



ELVES

41172





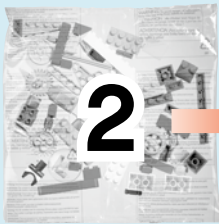

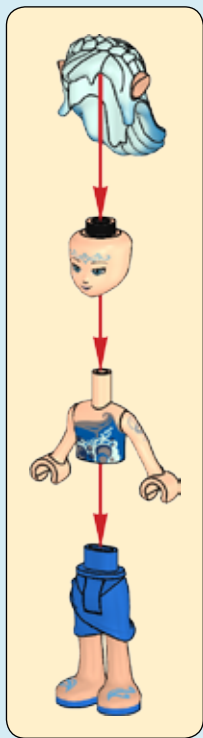
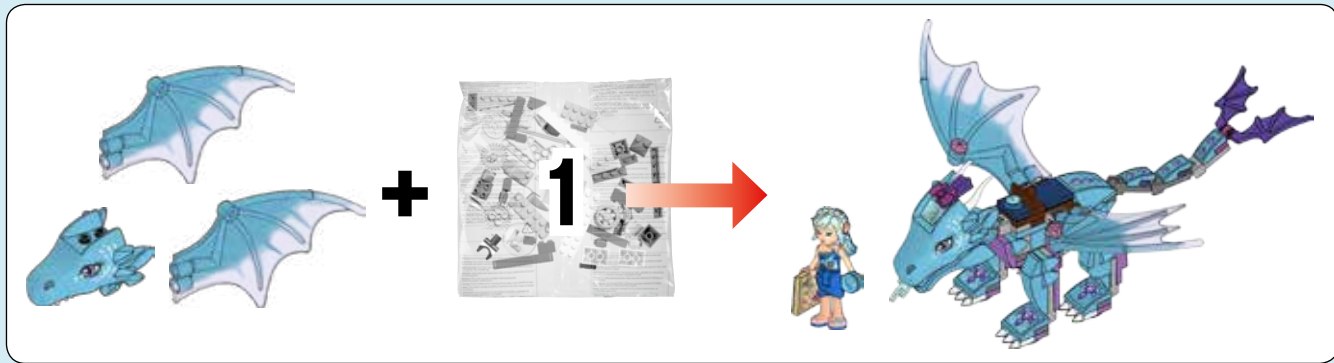

1

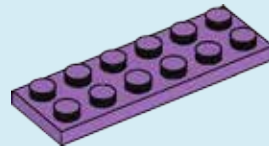

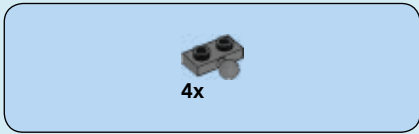

2

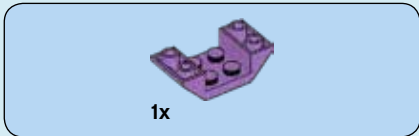
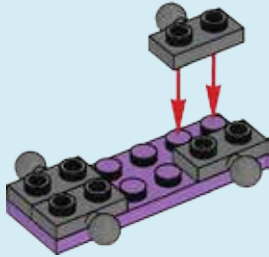

3

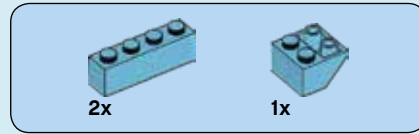
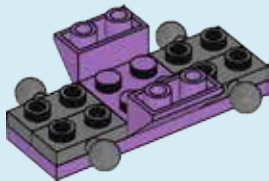

4

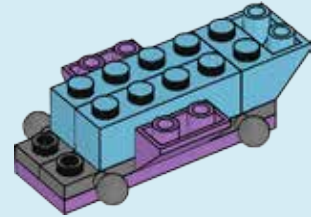

5

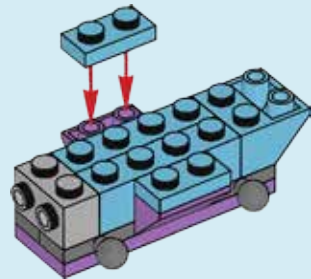



2x



1x

6

1



2

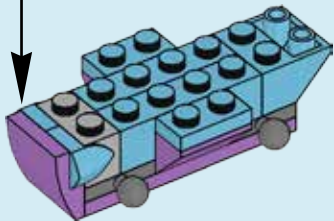

2x

7

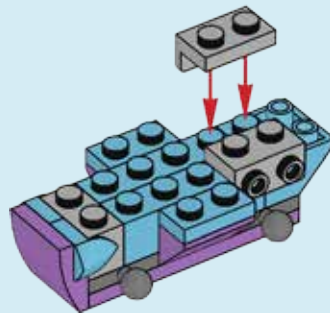



8

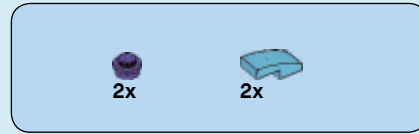
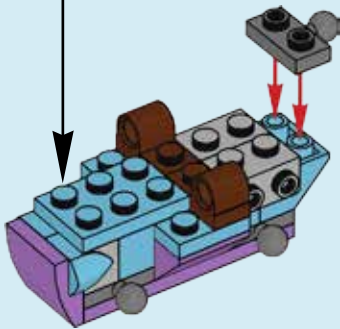

9

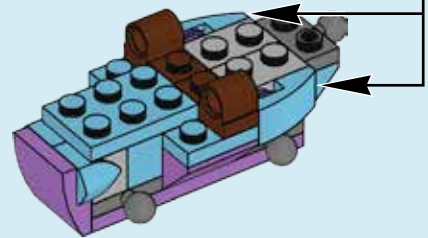
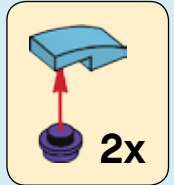



10

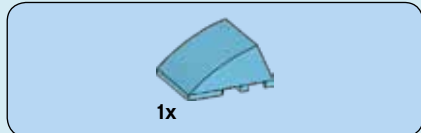
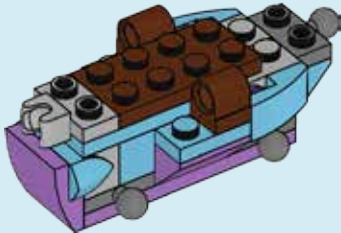

11

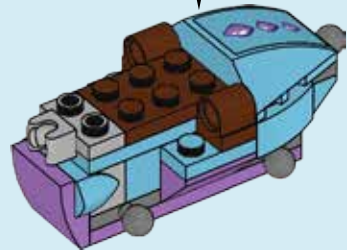
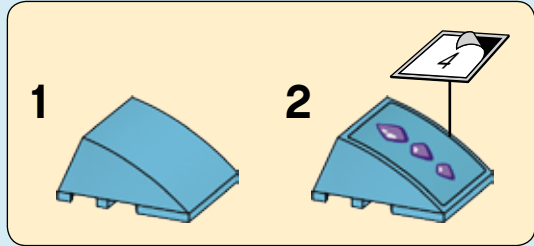



12

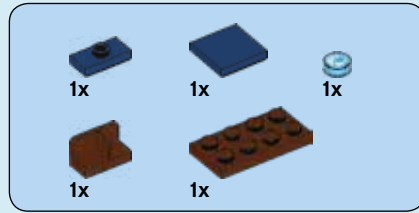
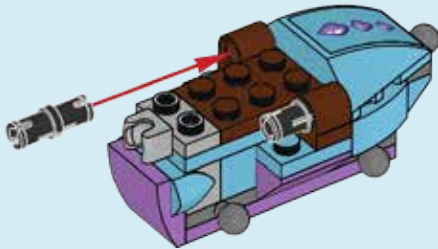

13

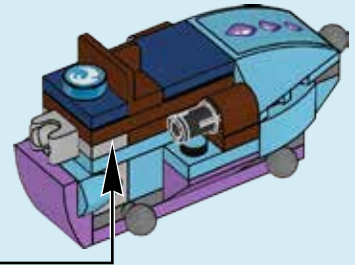



1x



1x

14

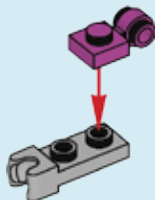

1x

15

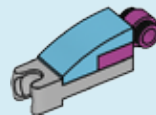

2x

16

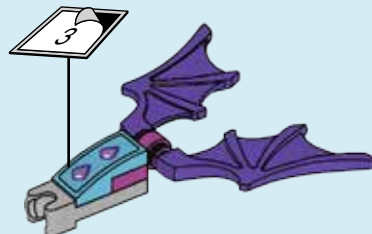

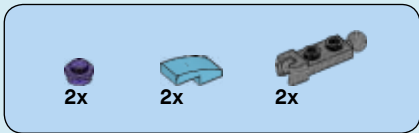

17

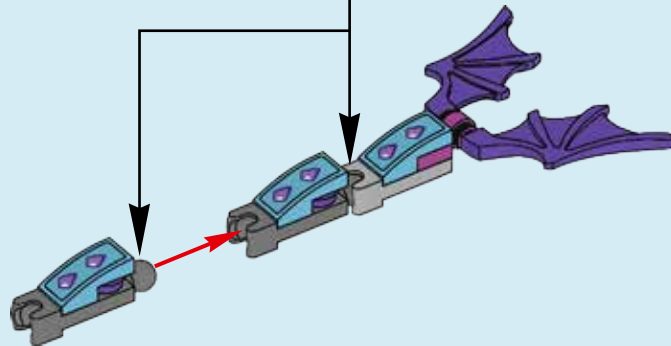
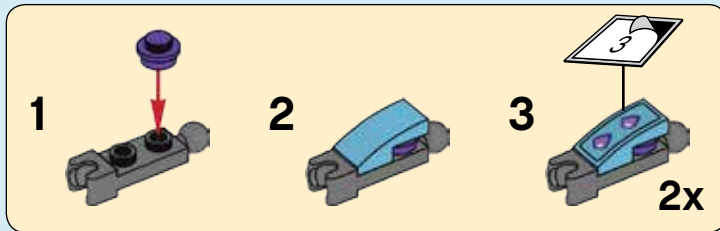

18

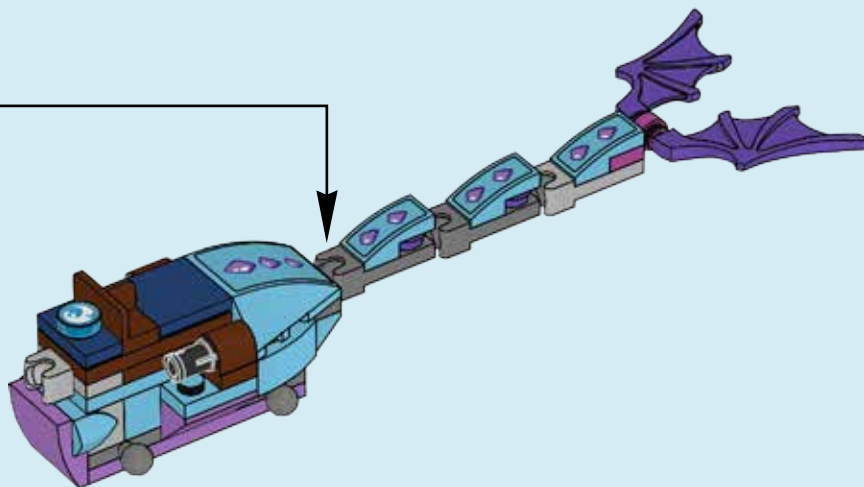



19

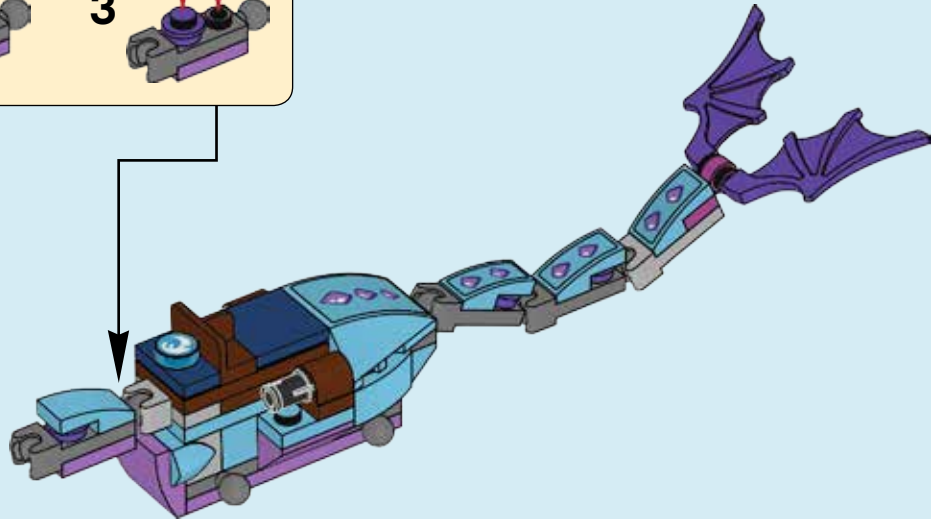
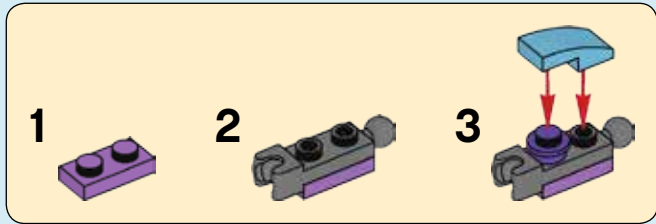

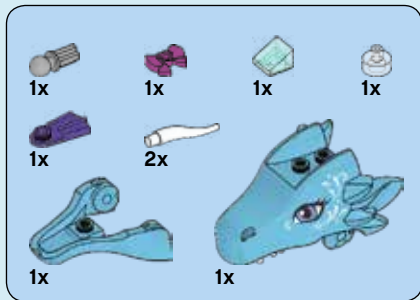

20

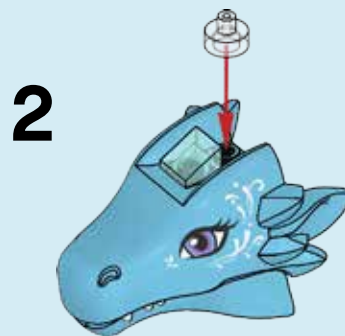
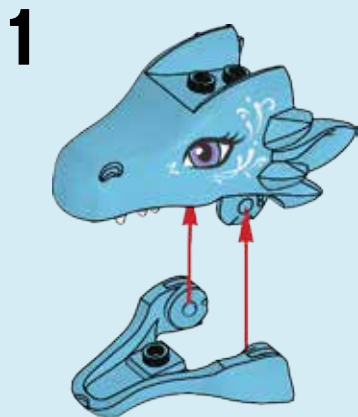

3

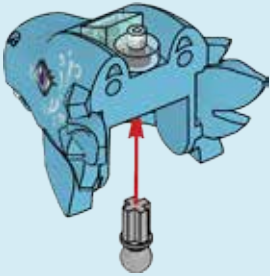

4



5

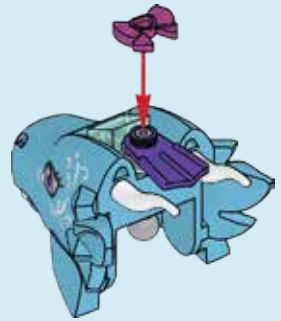

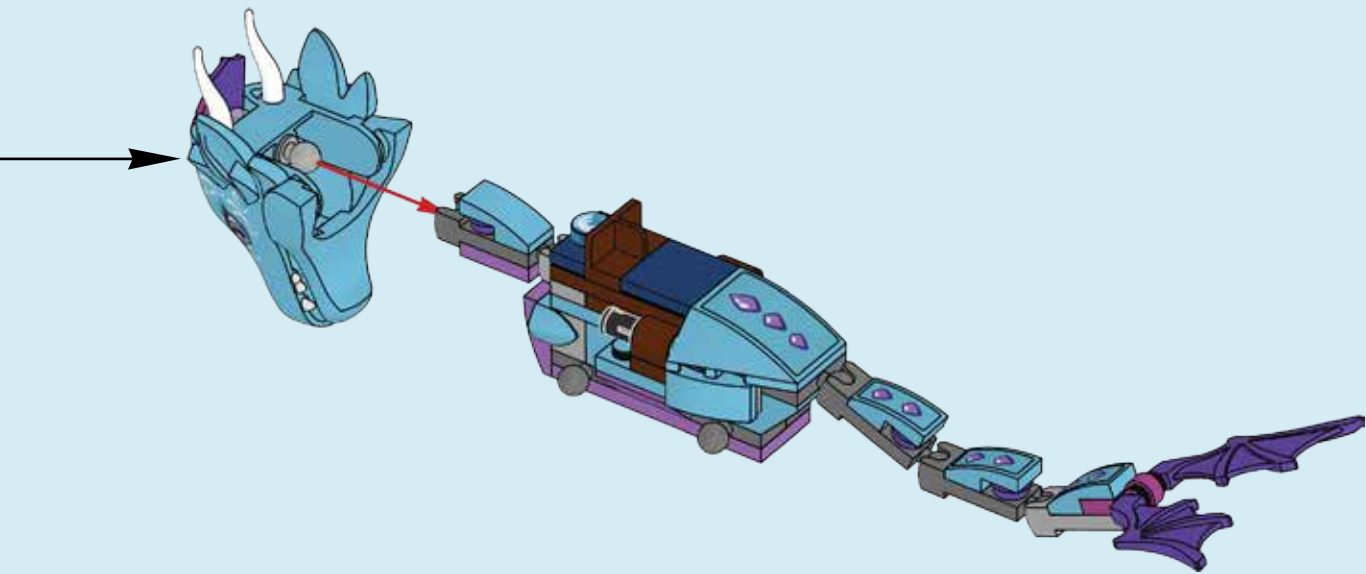

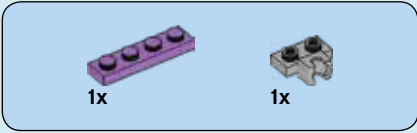
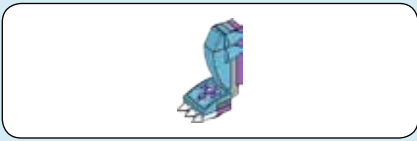

21

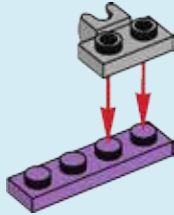

22

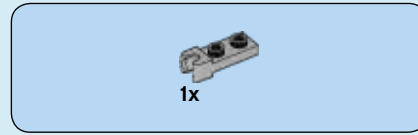
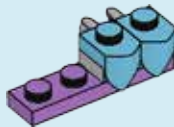

23

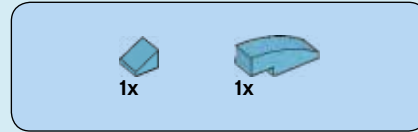
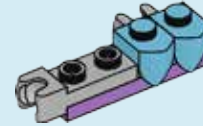

24

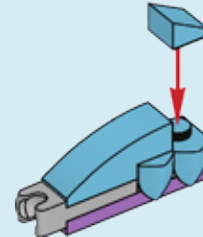



25

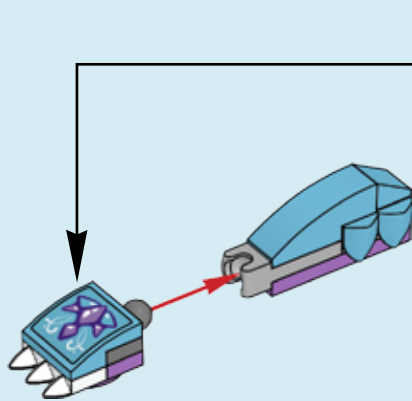

26

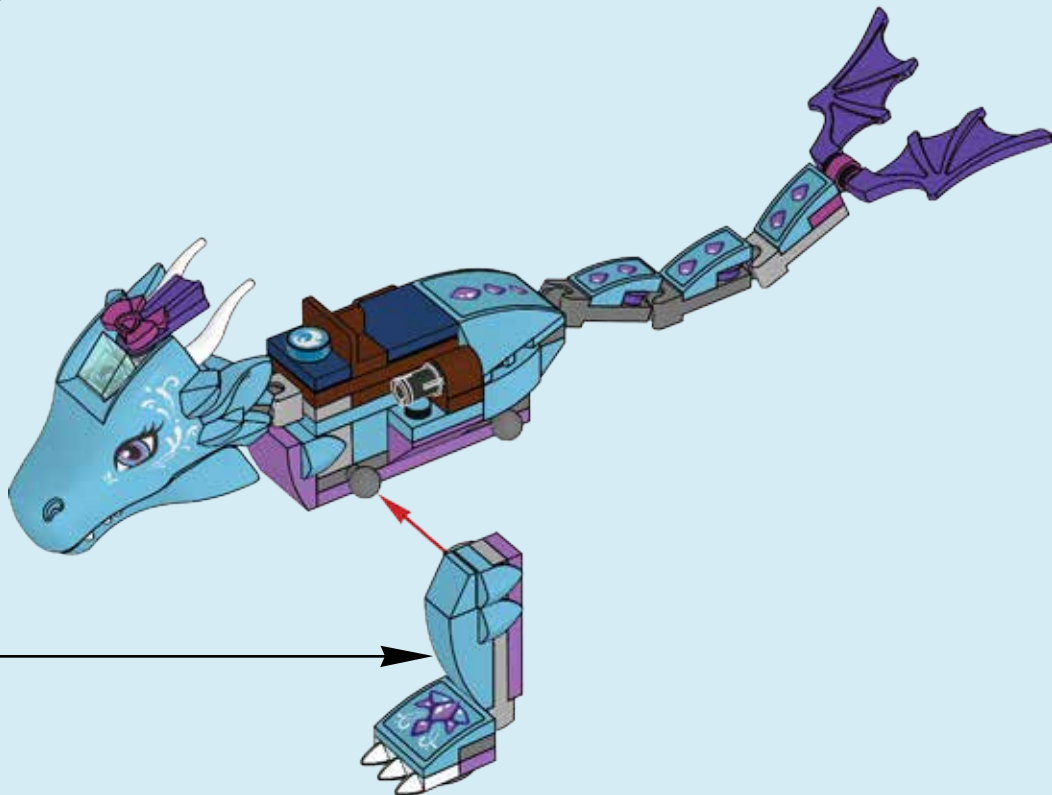

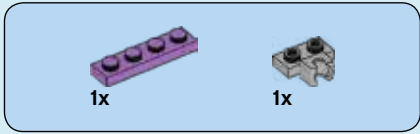

27

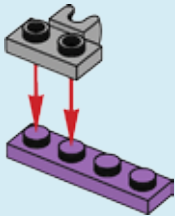

28

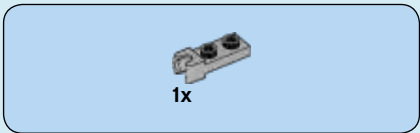
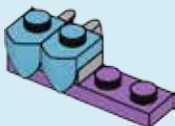

29

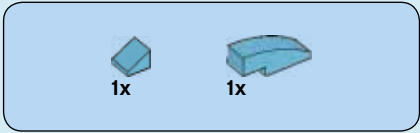
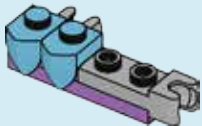

30

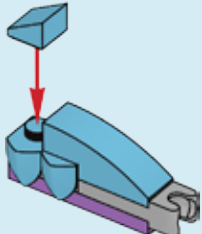



31

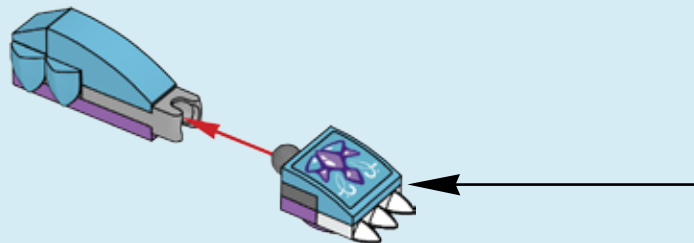

32

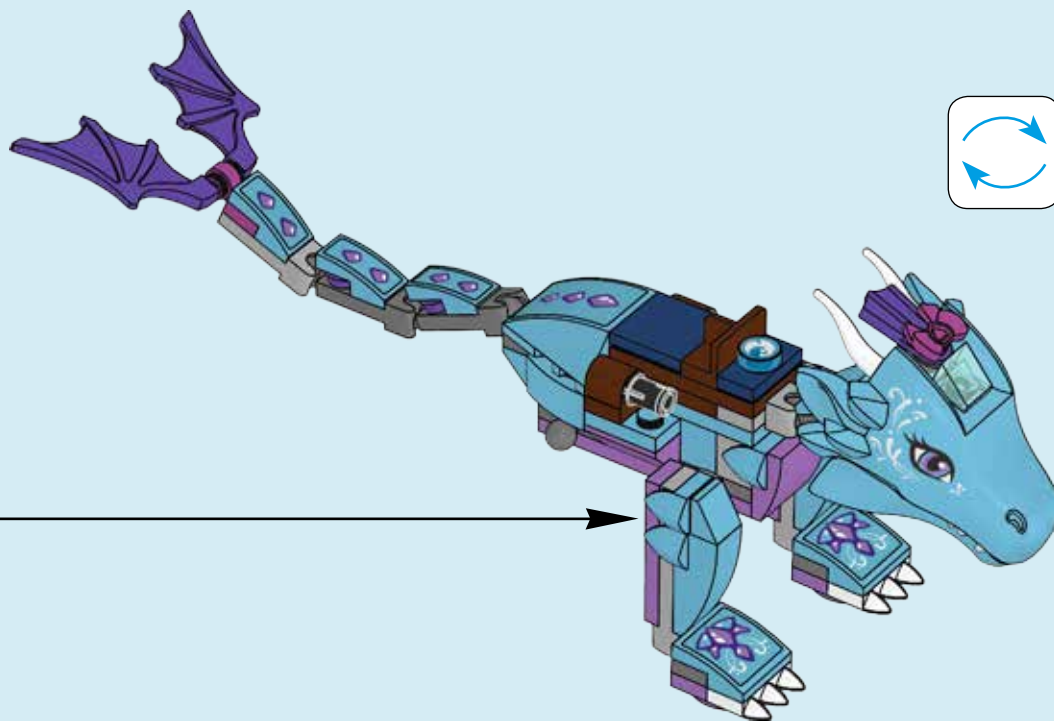

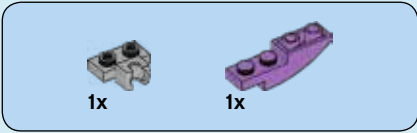

33

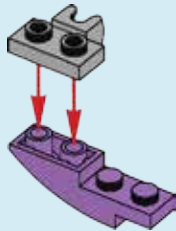

34

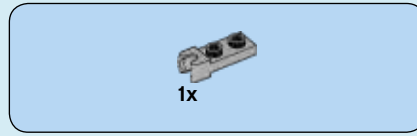
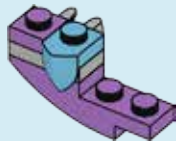

35

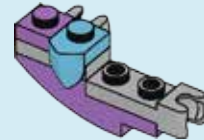

36

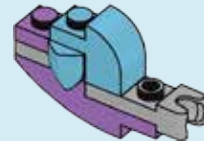

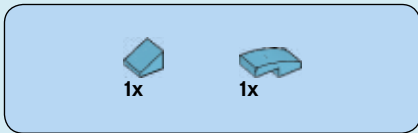

37

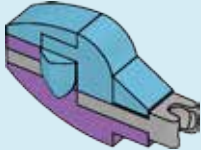

38

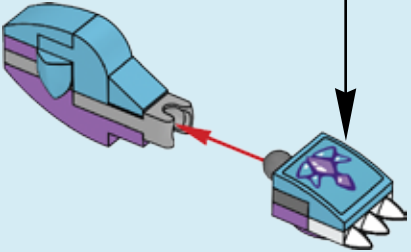
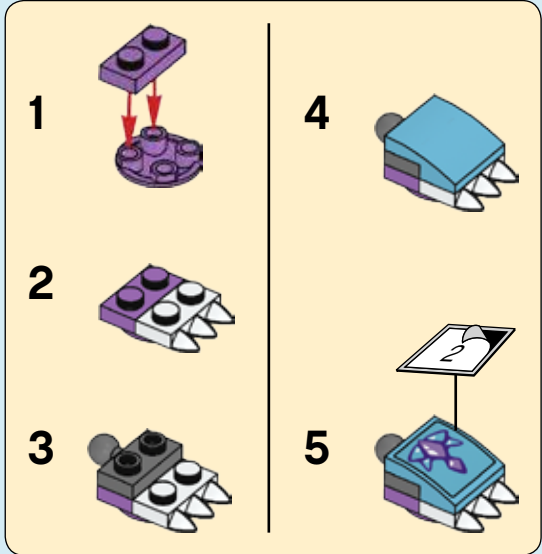

39

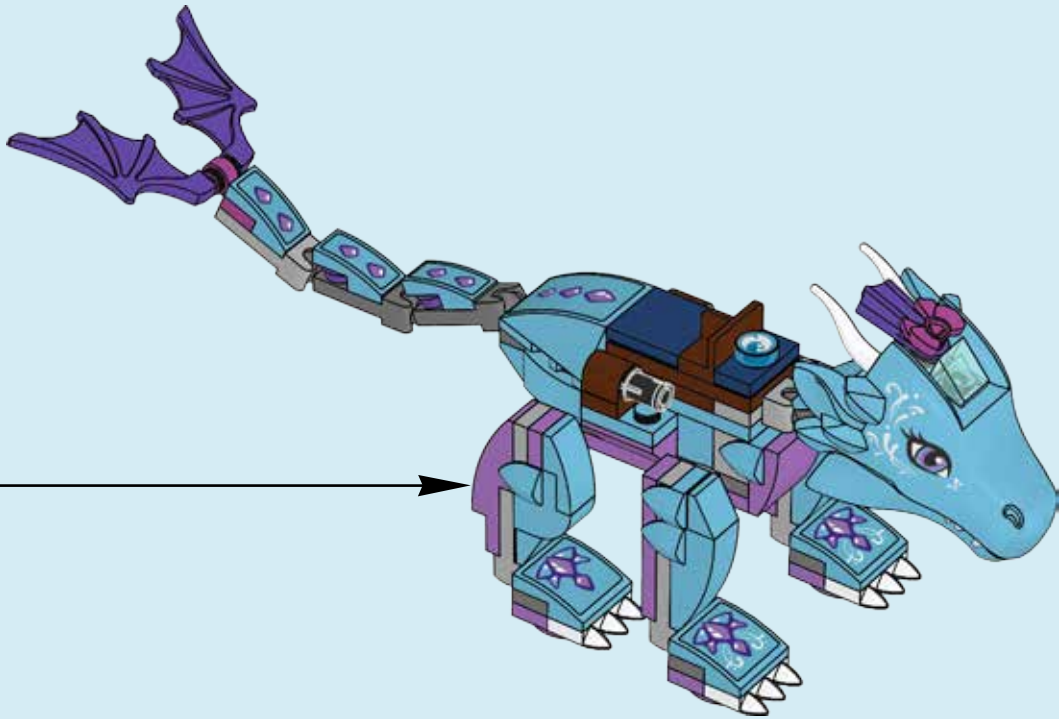



1x



1x

40

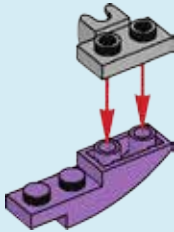

1x



1x

41

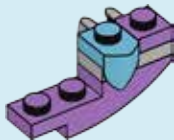

1x

42

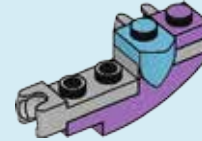

1x

43

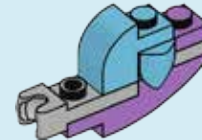



1x



1x

44

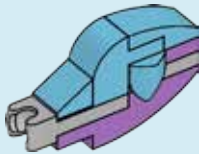

1x



1x



1x



1x



1x

45

1

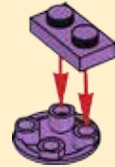

2



3



4

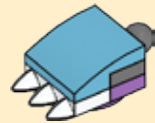

5

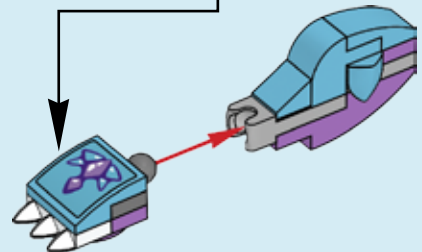

46

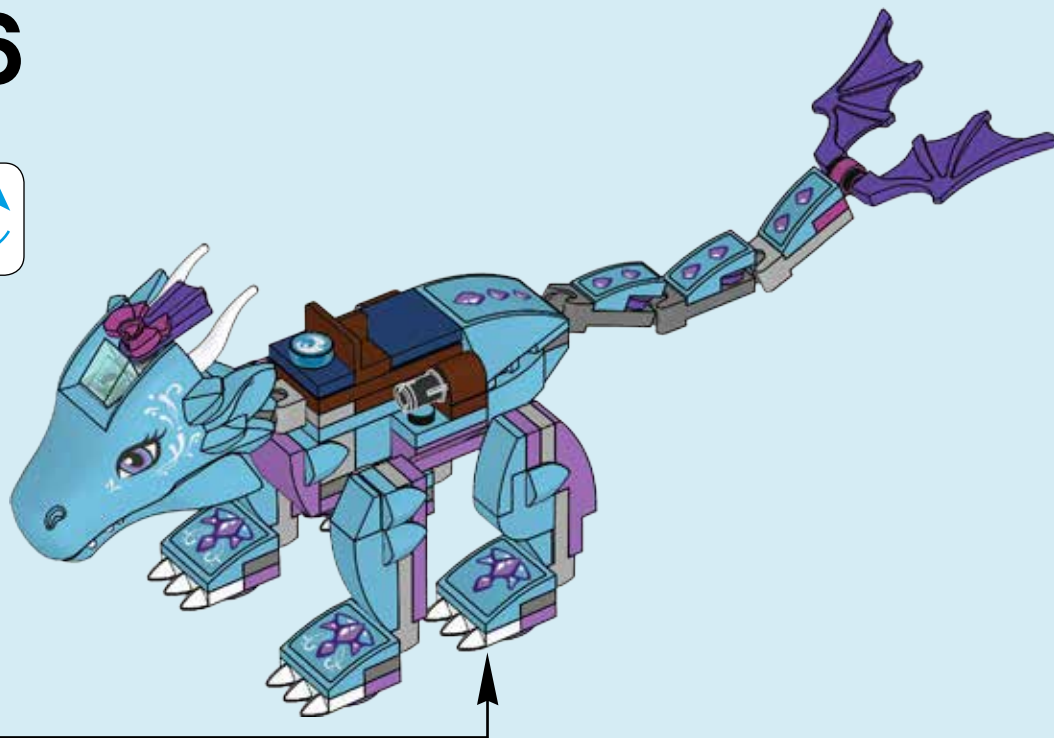
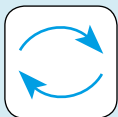

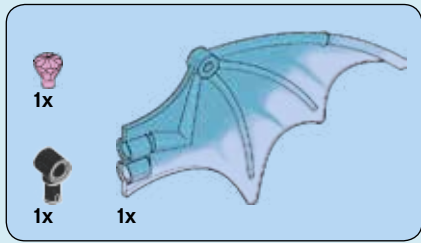

47

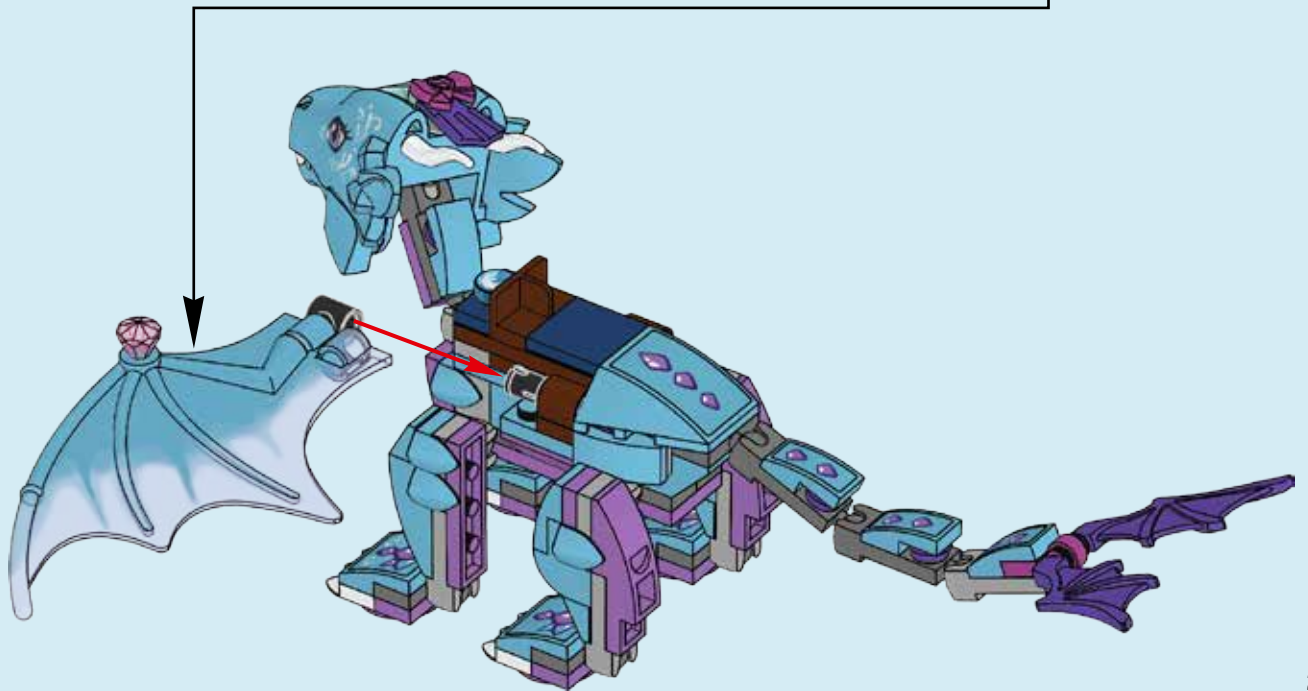
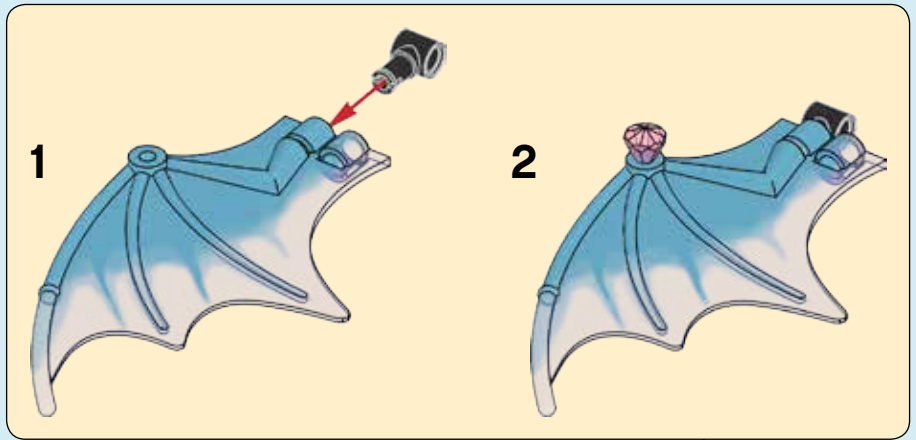

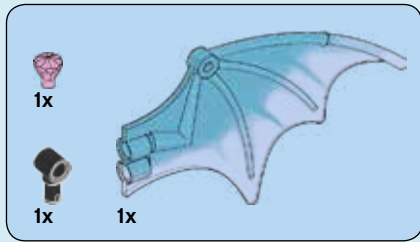

48

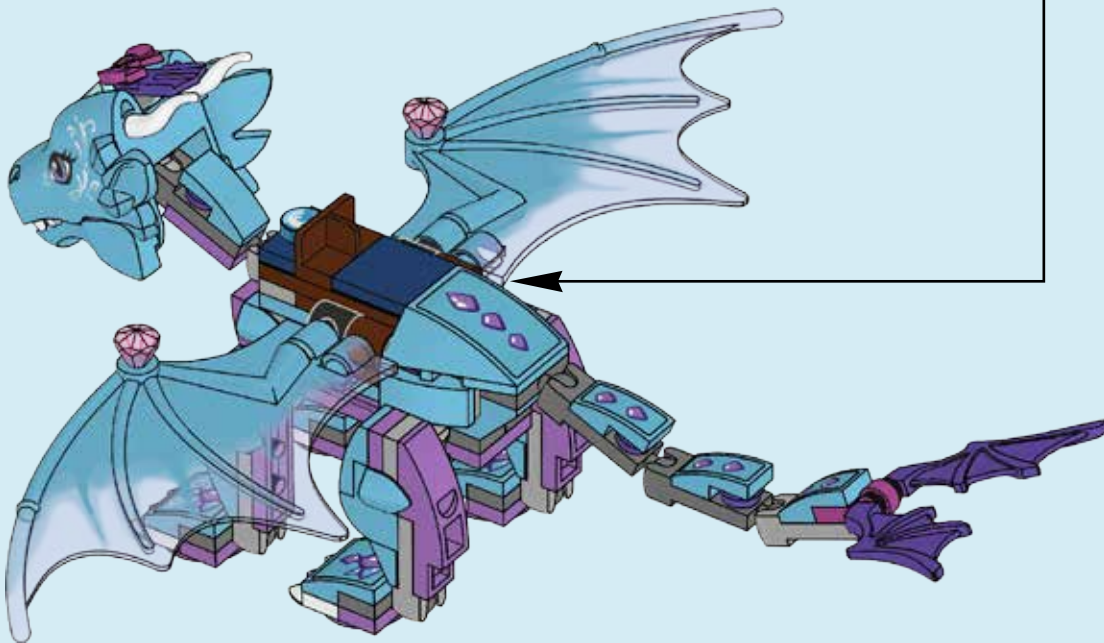
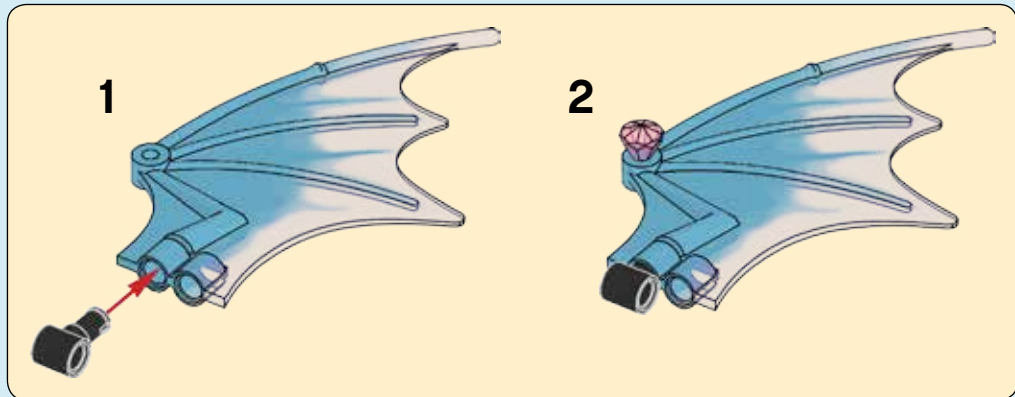



1x



1x

49

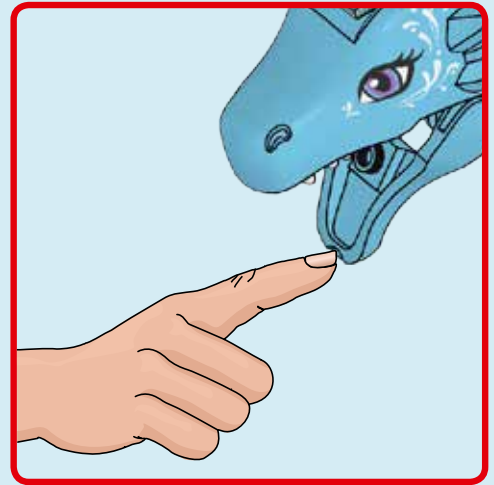

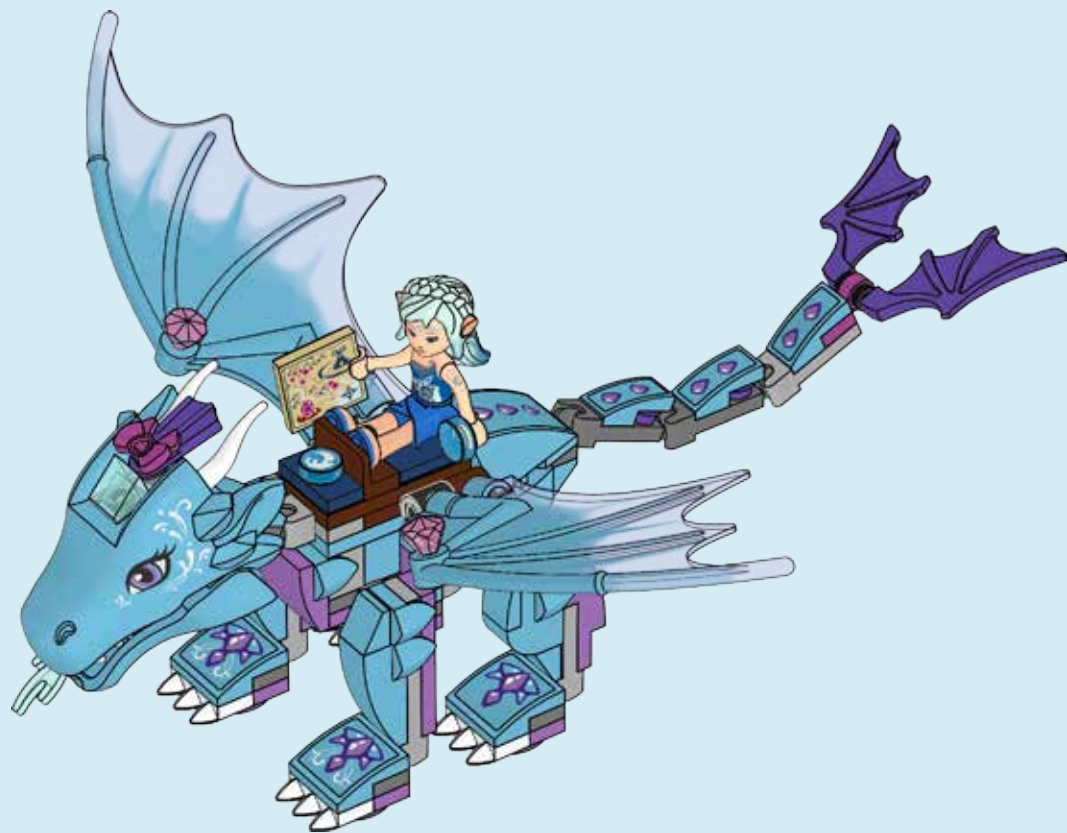

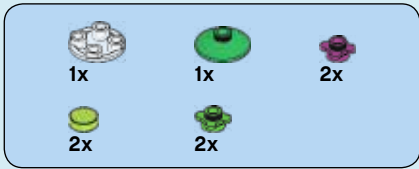
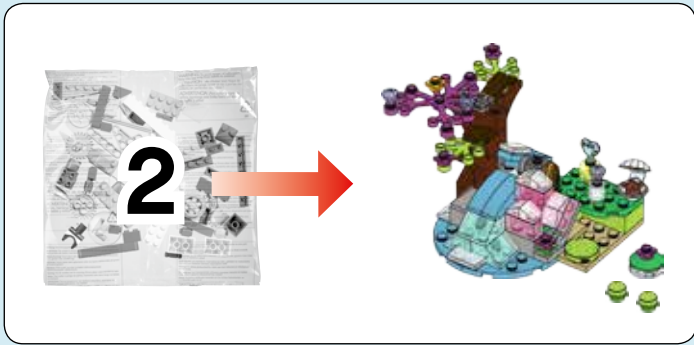

1

1



2

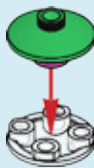

3

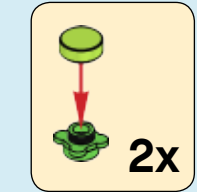

2x

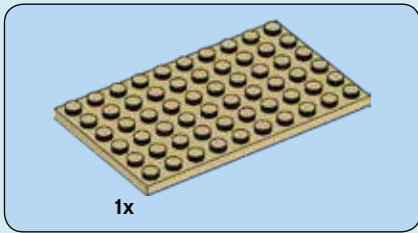

1

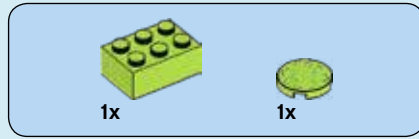
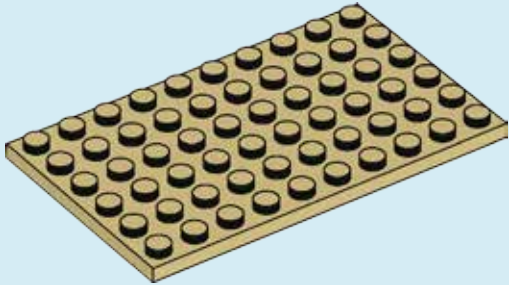

2

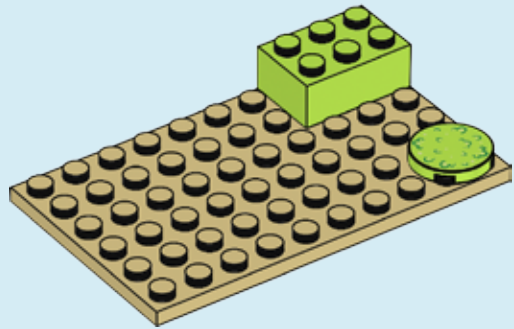

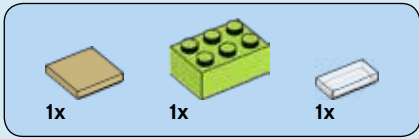

3

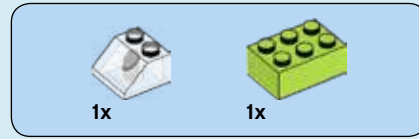
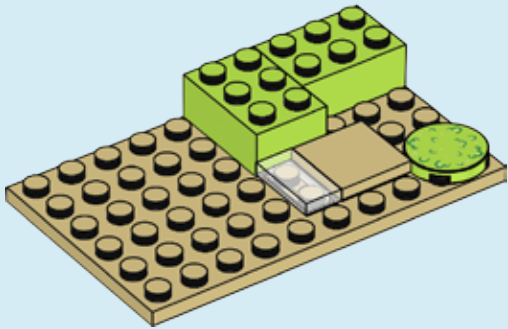

4

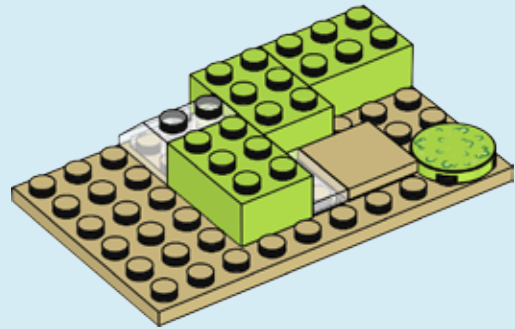

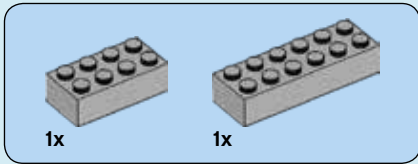

5

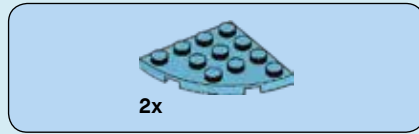
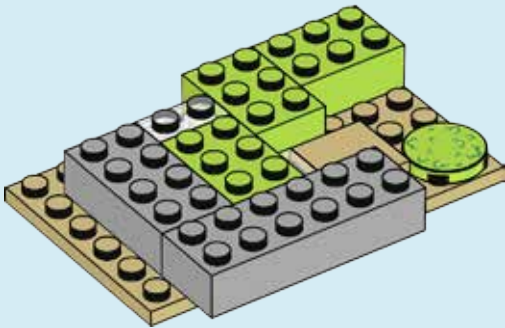

6

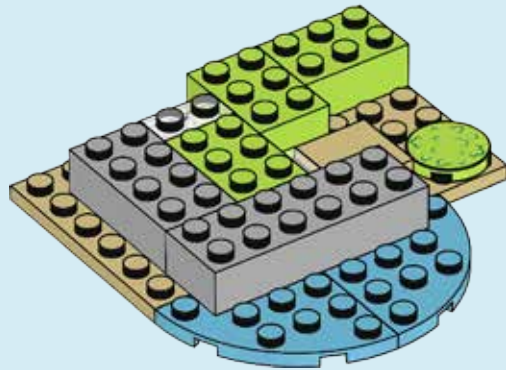

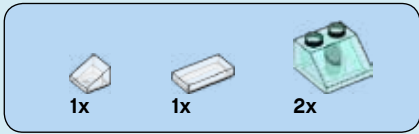

7

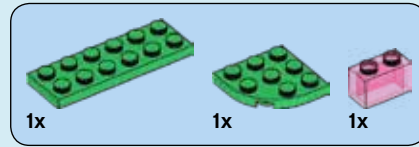
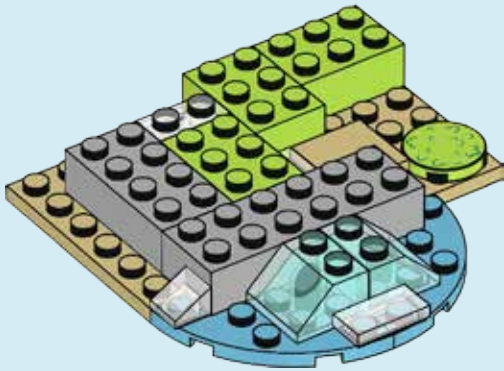

8

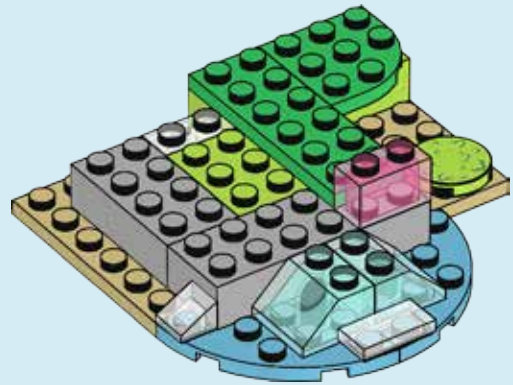



9

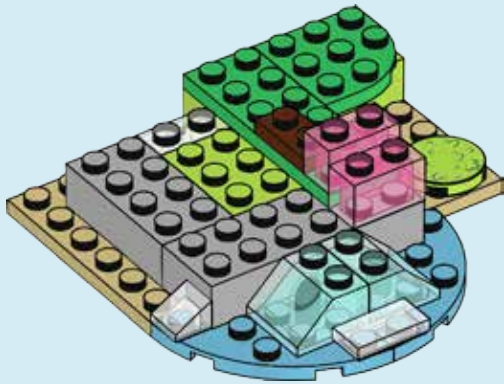



1x



1x

10

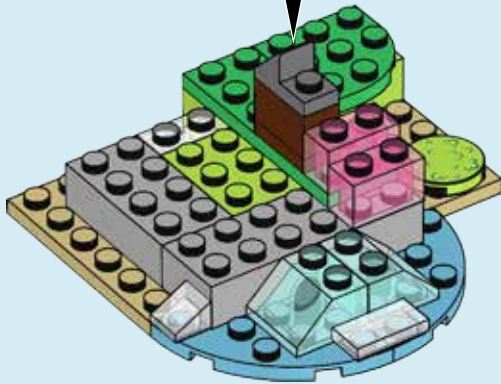
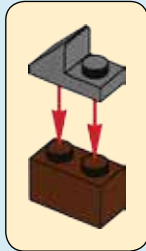

2x

11

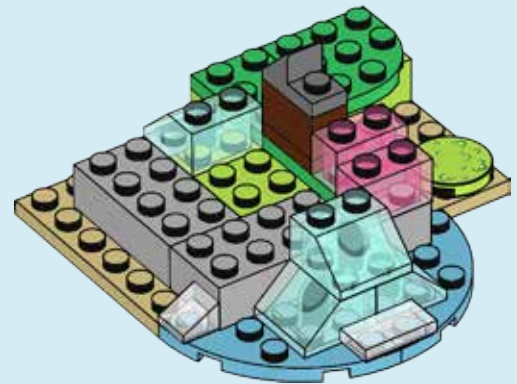

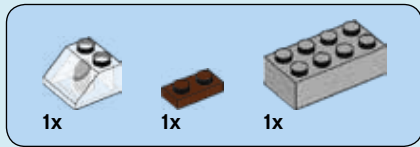

12

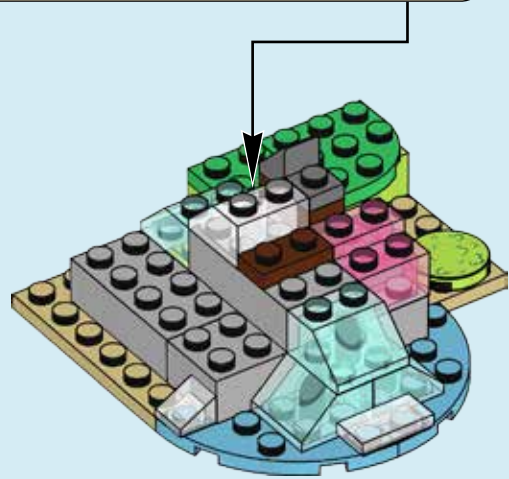
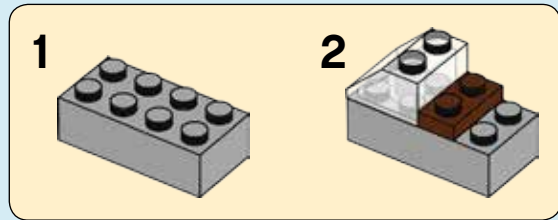



2x



1x

13



1x



2x

14

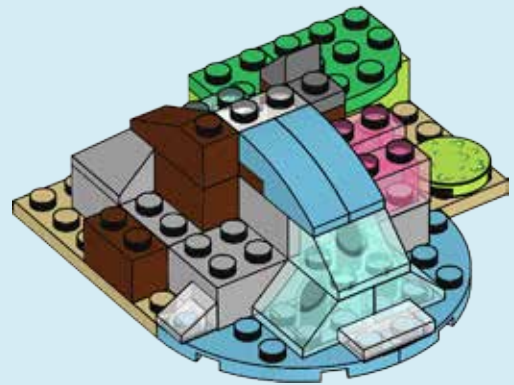

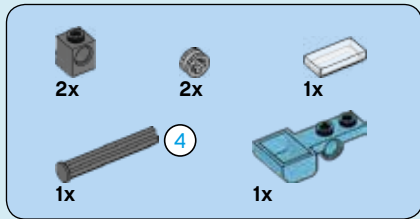

15

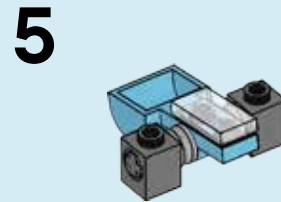
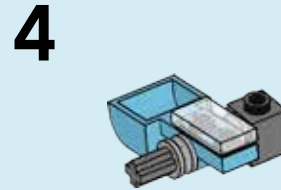
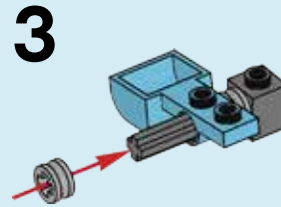
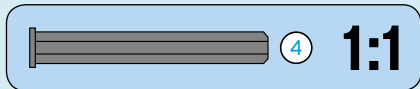
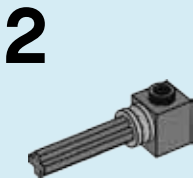
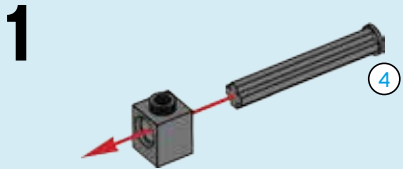

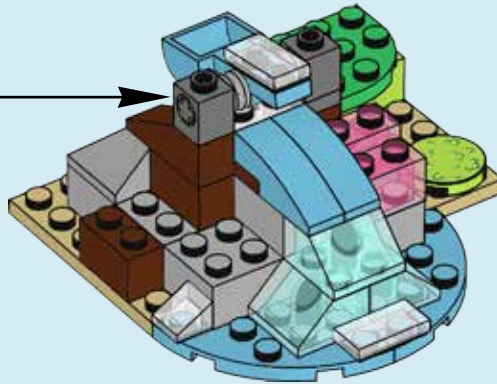
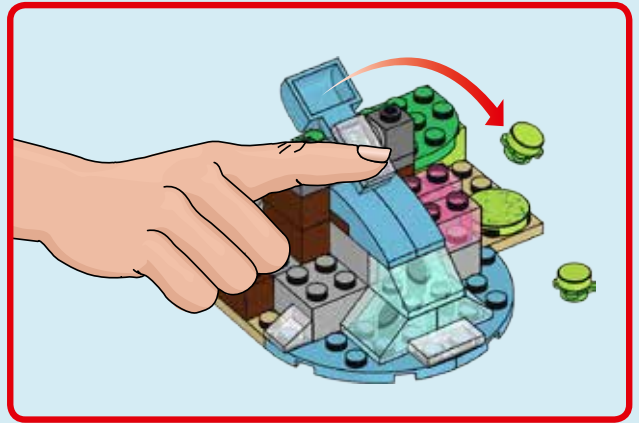

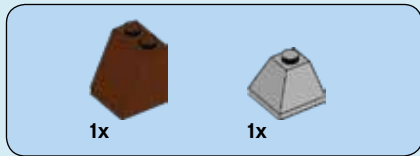

16

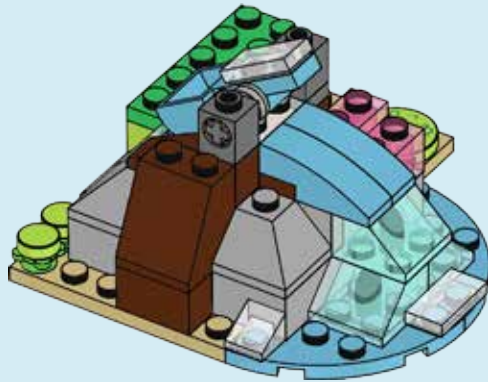

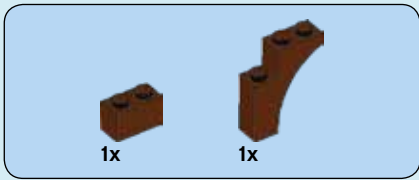

17

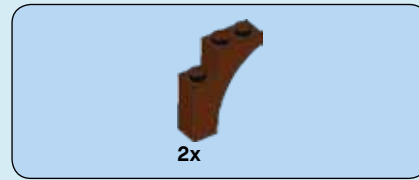
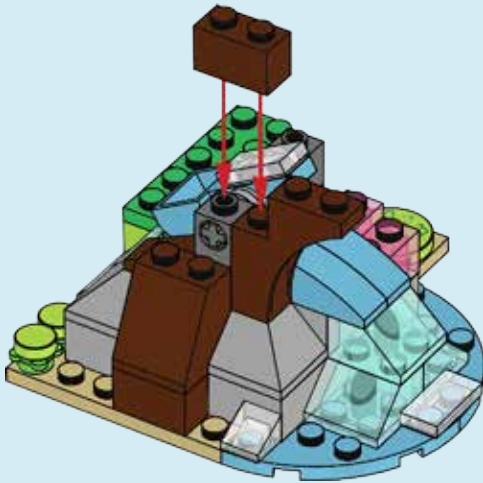

18

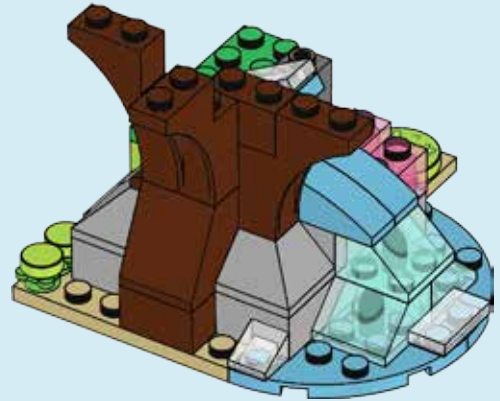



1x

19

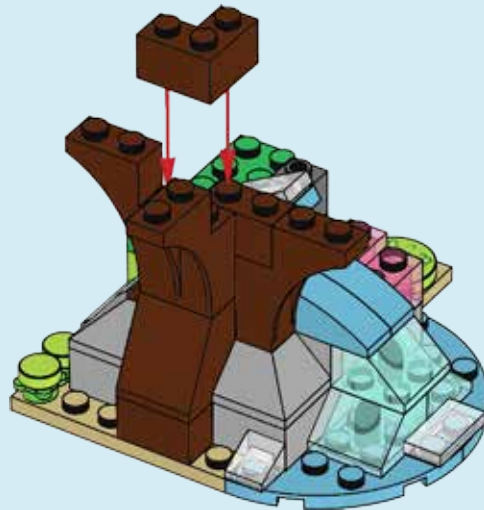



1x

20

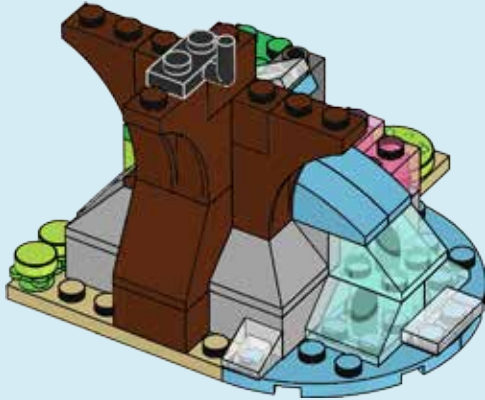

2x



2x

21

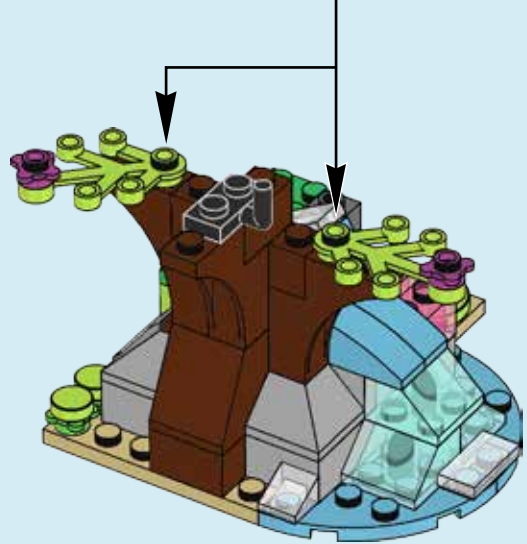
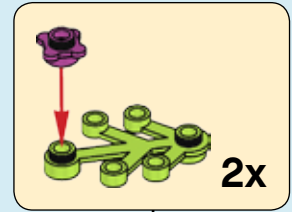



2x

22

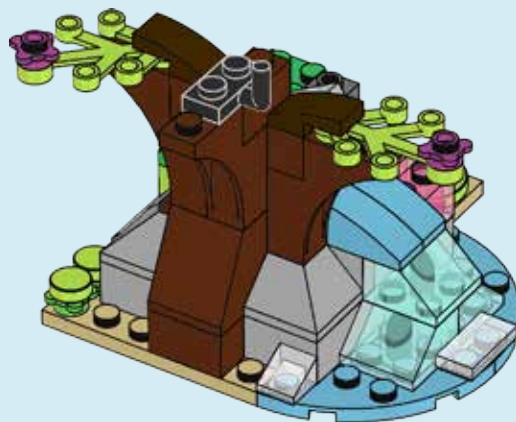

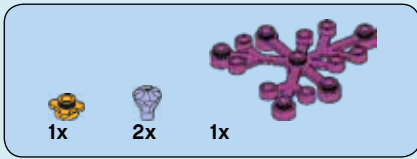

23

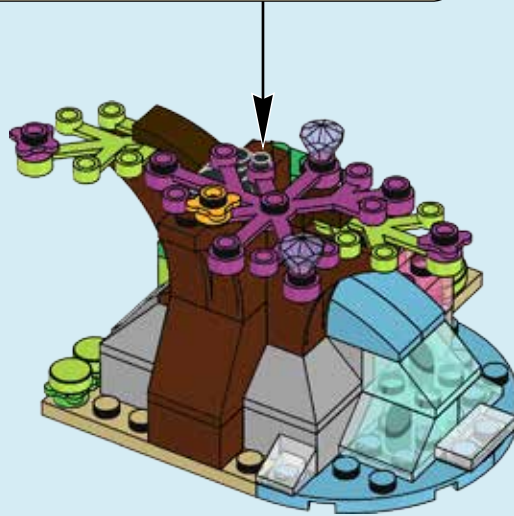
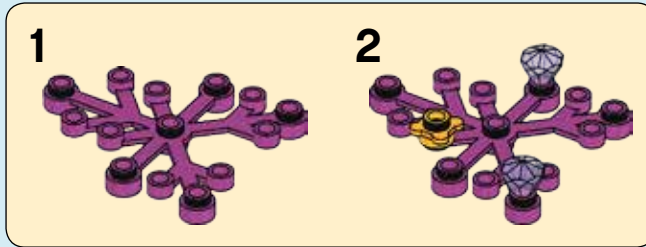



2x



1x

24

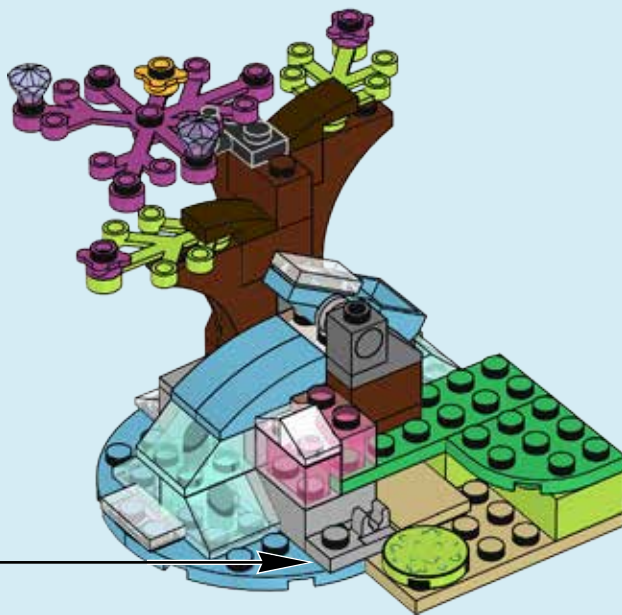
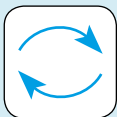



1x



1x

25

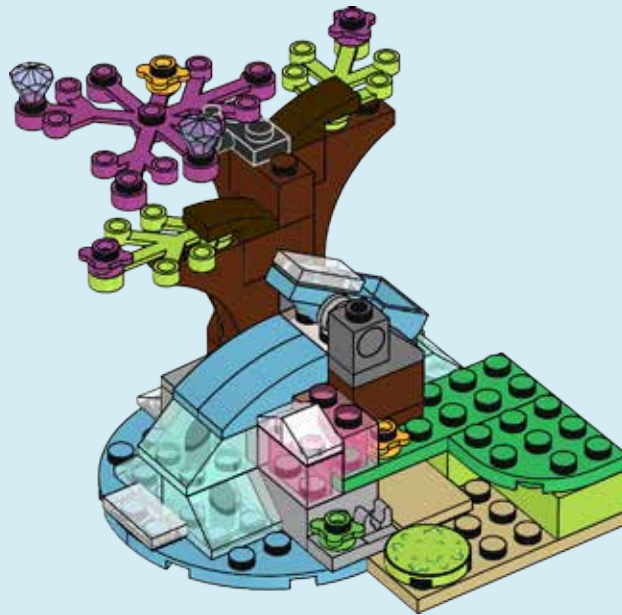



26

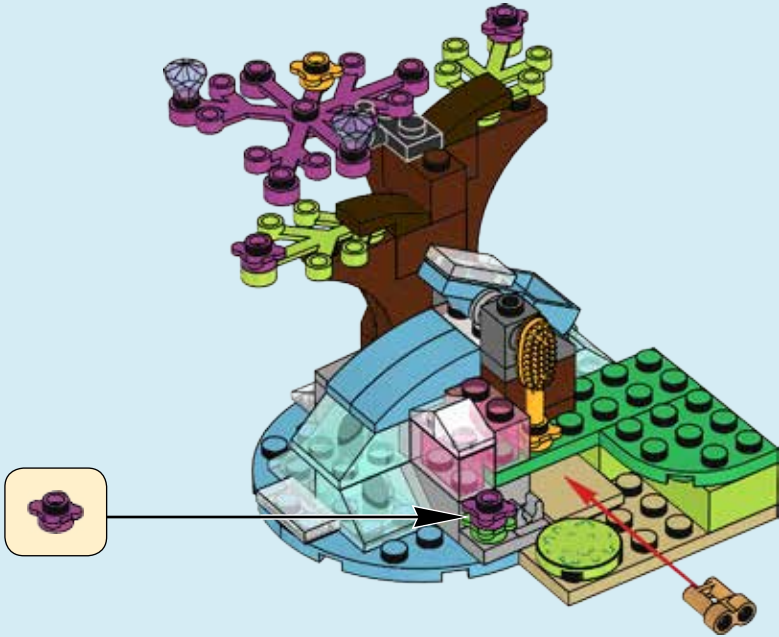

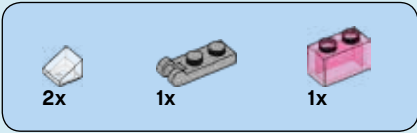

27

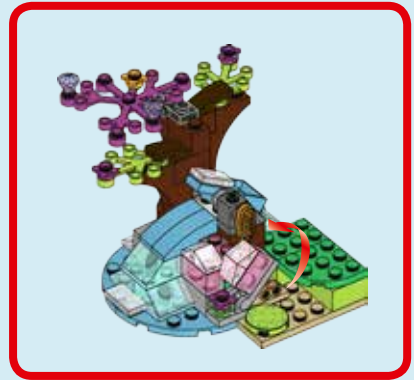

- 1
- 2
- 3

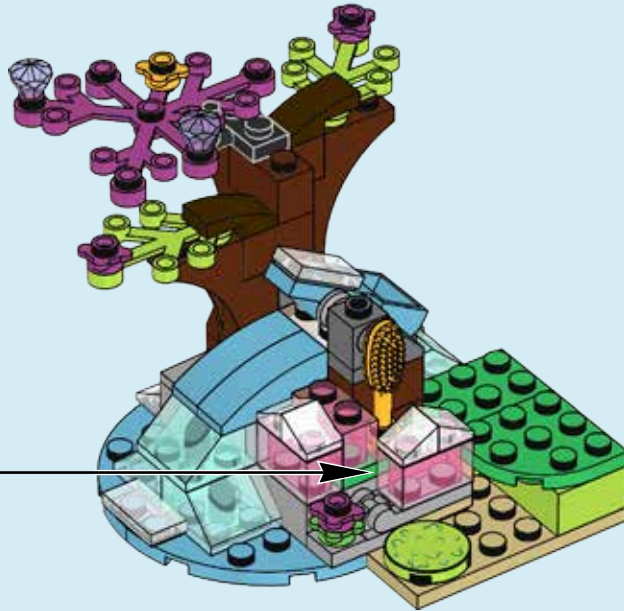



2x



1x

28

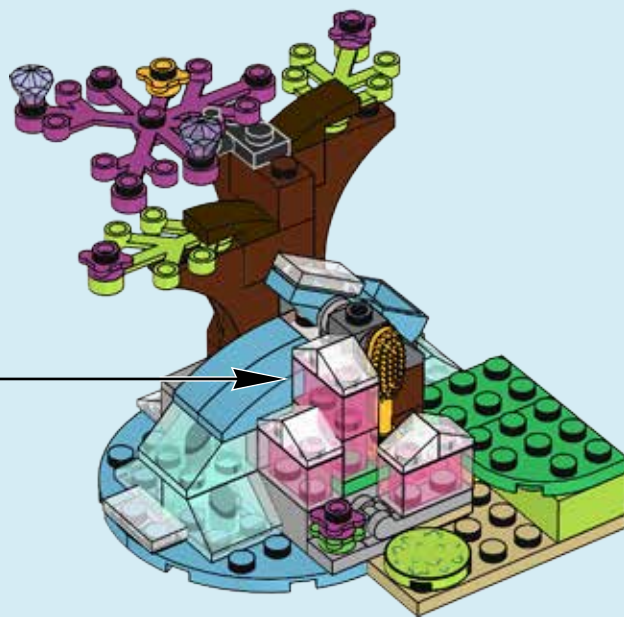

1

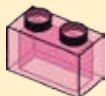

2





29

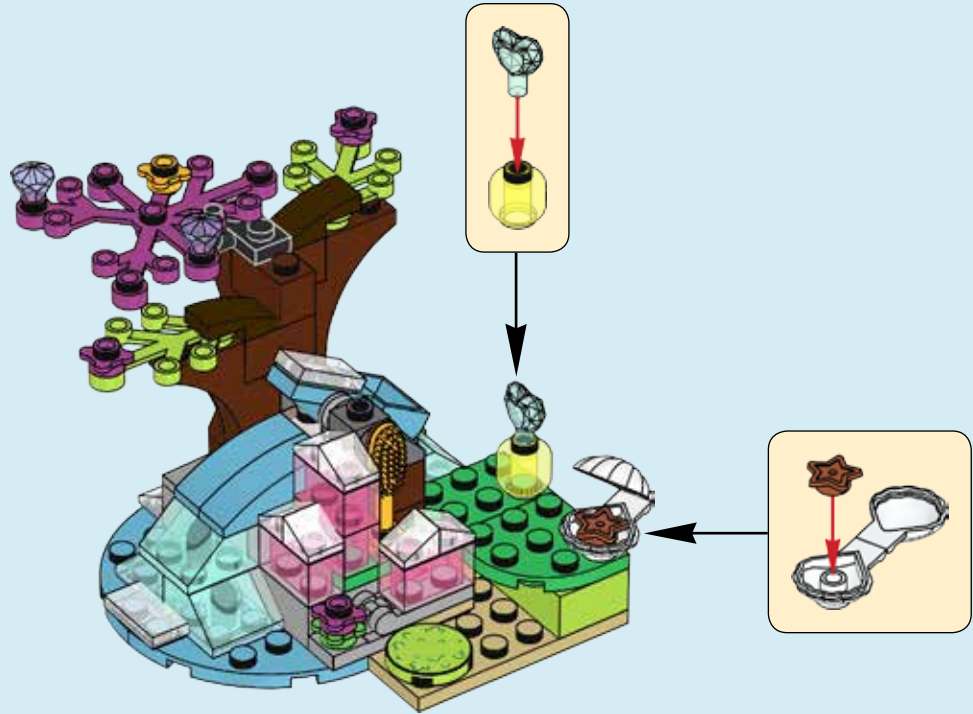



1x



1x

30

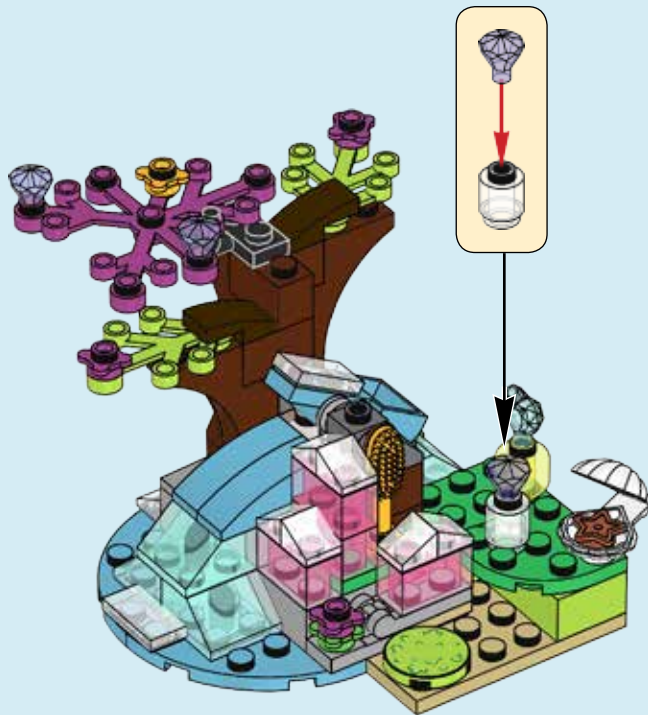



4x 6046381	2x 4129917	1x 6035618	2x 4211886	1x 4625027	1x 6071226	1x 6070756	4x 4619520	1x 6134564
2x 6032360	4x 6096995	1x 6133860	2x 6046943	2x 4211573	2x 4210639	4x 6035598	8x 6138770	2x 6056271
1x 6092203	2x 6057878	2x 6138664	5x 6078932	1x 4211375	1x 6069164	1x 4619513	2x 4655246	1x 6136945
1x 3006840	1x 6142097	4x 4211149	1x 6023827	1x 4211375	9x 6039479	2x 6036238	2x 6097419	1x 6136945
1x 6112751	1x 6142097	2x 4211150	1x 6037651	5x 6043656	3x 6039482	1x 6138779	8x 6071246	1x 6133334
7x 4244362	2x 6094069	2x 4211150	1x 6133021	1x 6015344	1x 6083620	1x 6138779	4x 6119126	1x 6133334
1x 4278412	3x 4220631	1x 4211200	2x 4619521	1x 4598526	5x 4566522	1x 6097099	1x 6034543	1x 6103116
3x 4569297	3x 4619599	1x 4211320	4x 6133800	2x 4654582	1x 6133801	1x 6073445	1x 4243668	1x 6102368
2x 622740	1x 4567908	1x 4211320	5x 4619512	2x 4216250	2x 6133818	4x 6070495	2x 4624184	1x 6135513
1x 6109893	1x 6062166	3x 6055086	1x 6139090	5x 6043639	1x 6092588	1x 4155537	1x 4185177	1x 6135513
3x 6103301	1x 379528	1x 4211197	2x 4619524	1x 4515369	1x 4205004	1x 6104423	1x 6141978	1x 6135537
			2x 6138771	2x 4211385	2x 6073231	1x 4646861		
			1x 6133798	1x 4211795	2x 4121715			
					1x 4569733			
						1x 4624185		
							2x 6133820	

Customer Service

Kundenservice

Service Consommateurs

Servicio Al Consumidor

LEGO.com/service or dial



00800 5346 5555 :



1-800-422-5346 :





Aira

Azari

Emily Jones

Farran

Naida



ELVES



ELVES







ELVES



41176



41171



41174



41175



41173



41172





ELVES



Free
app
game



 LEGO.com/elves

Apple, the Apple logo and iPad are trademarks of Apple Inc.
Google Play is a trademark of Google Inc.

 Download on the
App Store

ANDROID APP ON
 **Google play**

WIN

GO TO WWW.LEGO.COM/PRODUCTFEEDBACK AND
GIVE US YOUR SHORT **FEEDBACK** ABOUT THIS
LEGO® SET FOR A CHANCE TO WIN
A COOL LEGO PRIZE.



LEGO.com/productfeedback

GEWINNE



Erzähle uns auf
www.LEGO.com/productfeedback

etwas über die Erfahrungen, die du mit
diesem LEGO® Set gemacht hast, und
sichere dir die Chance auf einen coolen
LEGO Preis!

GAGNE



Rends-toi sur
www.LEGO.com/productfeedback

et donne-nous quelques commentaires
sur ce produit LEGO® pour avoir une
chance de gagner un prix LEGO !

GANAN



Visita
www.LEGO.com/productfeedback

y envíanos tu opinión acerca de este set
LEGO®. ¡Participarás en el sorteo de un
premio LEGO!

获取奖品



登录
www.LEGO.com/productfeedback

给出关于此乐高®套装的简短反馈，
就有机会获得炫酷乐高奖品