

NEO4

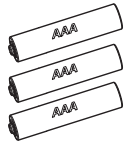

1.5V AAA

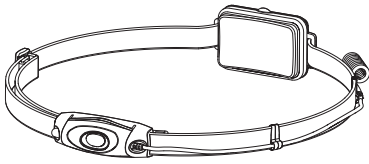
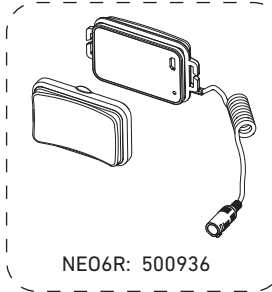

NEO6R: 500936

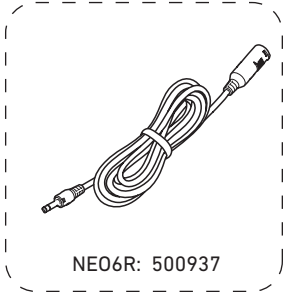

NEO6R: 500937

+

NEO6R

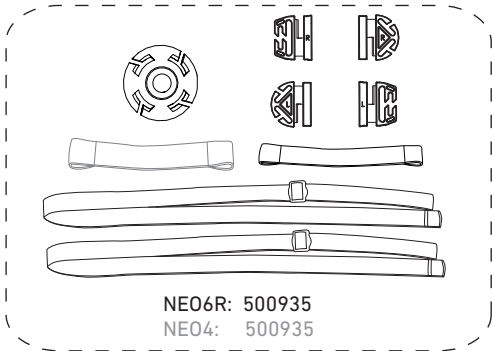
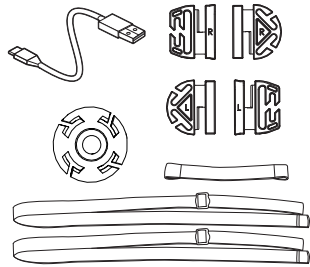
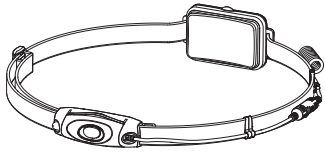

NEO6R: 500935
NEO4: 500935

1 NEO4

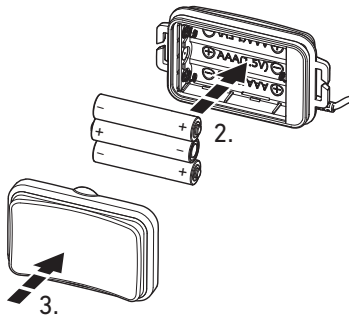
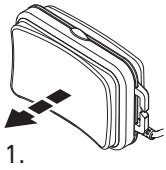

2 NEO6R

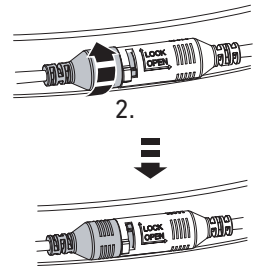
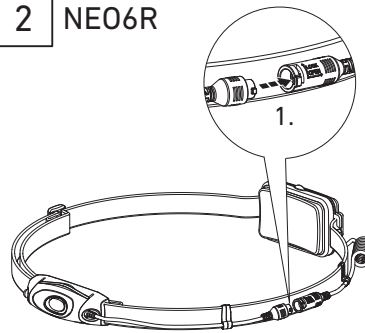

3

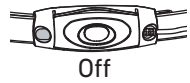

Off

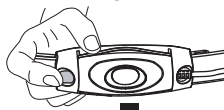

Constant Current Mode

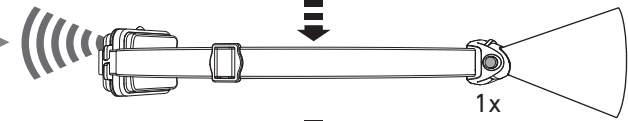

Power

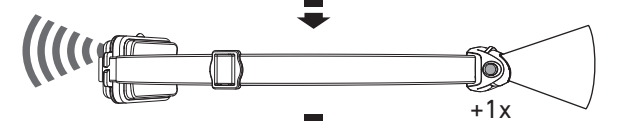

Low Power

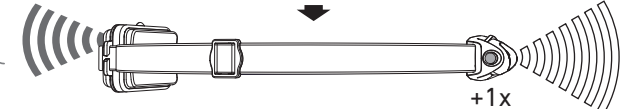

Blink



Hold 1sec

+

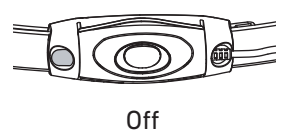

Off

4

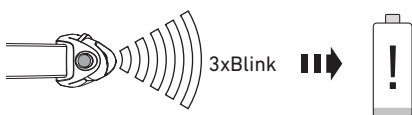

3xBlink



5 NEO6R

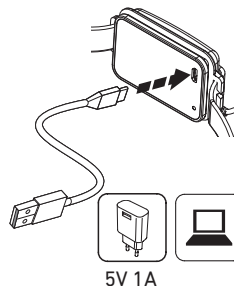
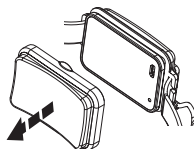

5V 1A

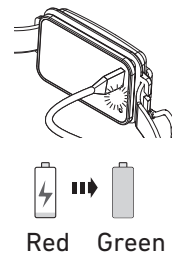

Red Green

6

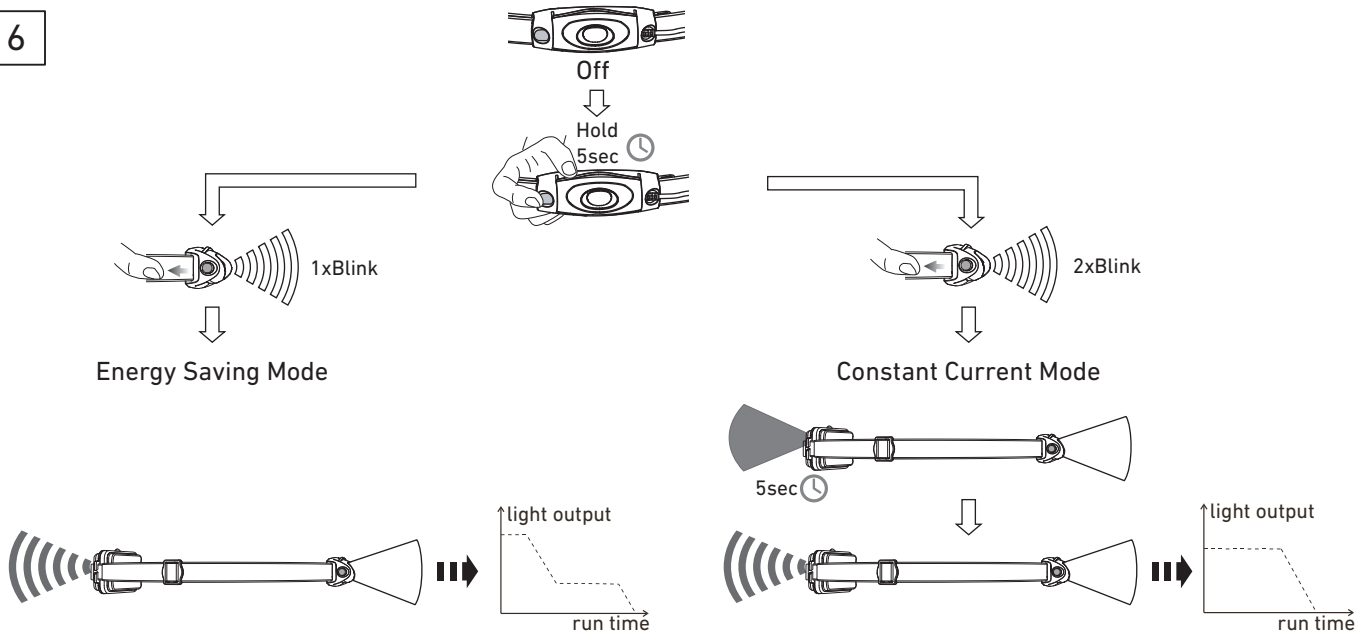

7

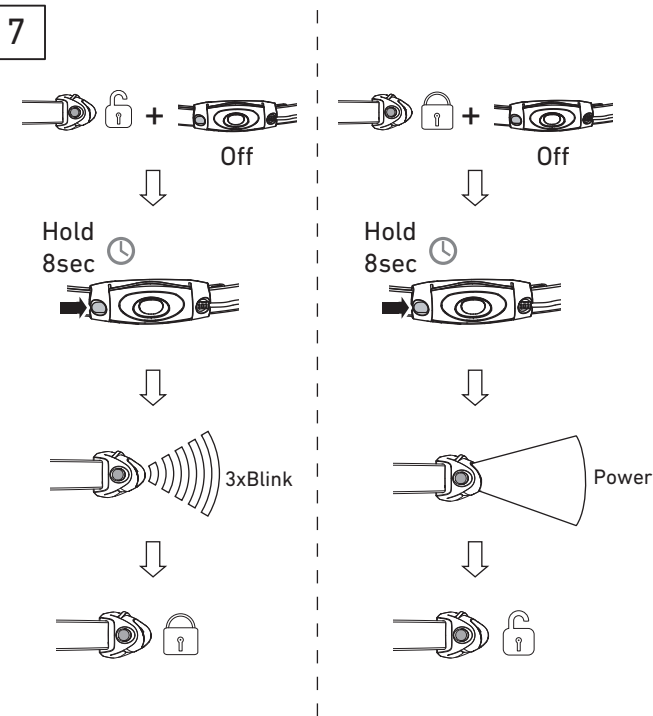

8

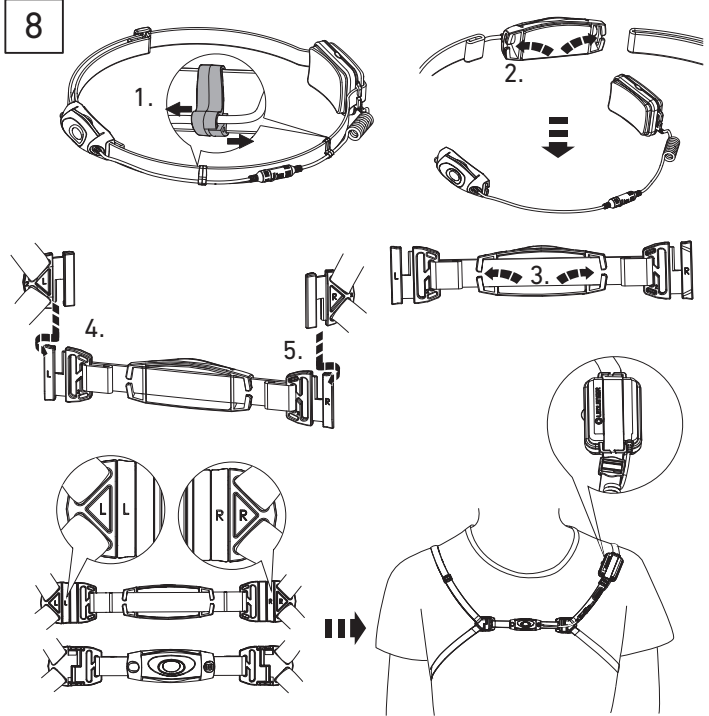

9

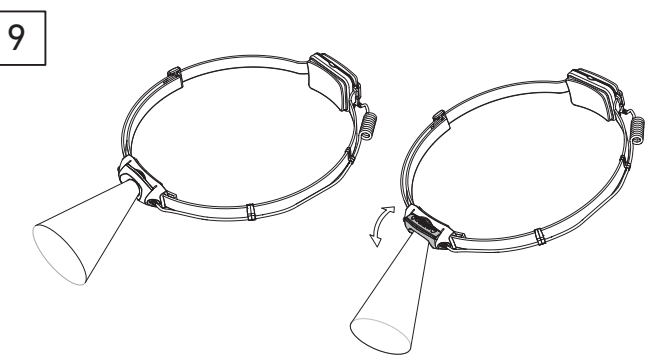

10

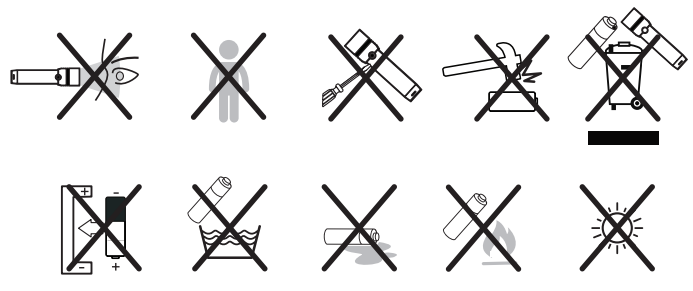
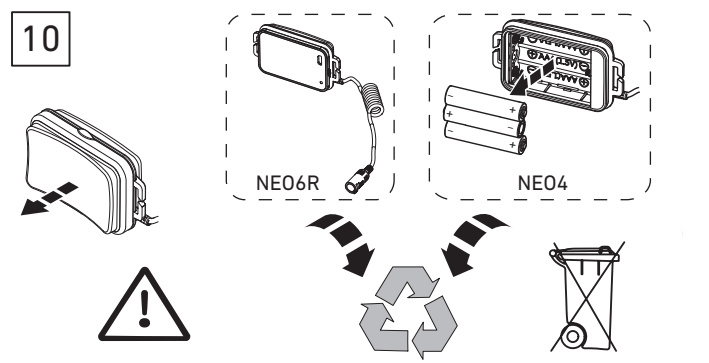

Ledlenser GmbH & Co. KG
Kronenstr. 5-7 • 42699 Solingen • Germany
Phone +49 212/5948-0 Fax +49 212/5948-200
info@ledlenser.com

www.ledlenser.com

CE

NE04/NE06R_V.01
28.11.2017
1J12A0198