

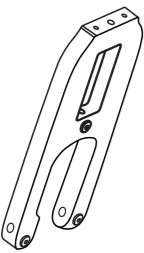

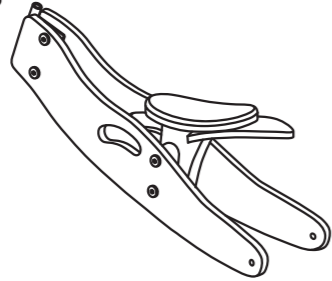
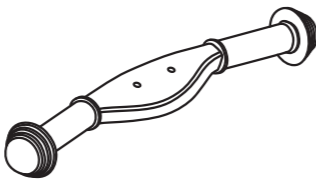
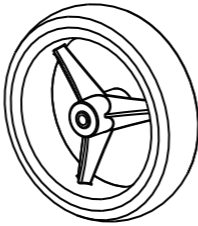

MINI 2 IN 1

CE Made In China

⚠ WARNING/ACHTUNG/ATTENZIONE!

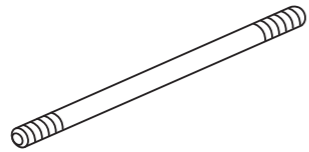
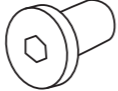
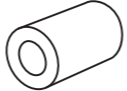
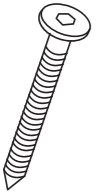
Must be assembled by adult. הוראום הרכבה ע"י מבוגר.
Parents or adult supervision is recommended at all times.
Deve essere montato da un adulto.
E' sempre consigliata la supervisione di un genitore o di un adulto.

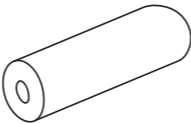
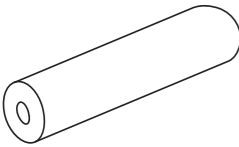
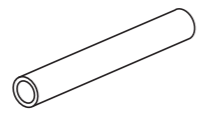
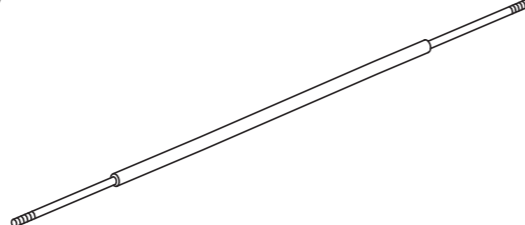
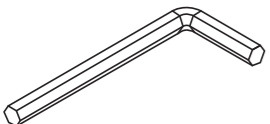
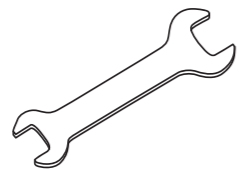
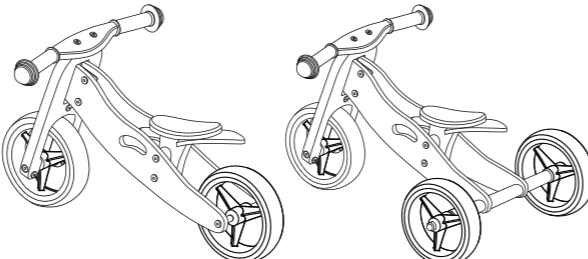
<p>A</p>  <p>x 1</p>	<p>B</p>  <p>x 1</p>	<p>C</p>  <p>x 1</p>	<p>D</p>  <p>x 3</p>
<p>E</p>  <p>x 1</p>	<p>F</p>  <p>x 2</p>	<p>G</p>  <p>x 4</p>	<p>H</p>  <p>x 2</p>
<p>I</p>  <p>x 2</p>	<p>J</p>  <p>x 2</p>	<p>K</p>  <p>x 6</p>	<p>L</p>  <p>x 2</p>
<p>M</p>  <p>x 1</p>	<p>N</p>  <p>x 4</p>	<p>O</p>  <p>x 1</p>	
<p>P</p>  <p>x 2</p>	<p>Q</p>  <p>x 2</p>		

DE FÜR SPÄTERES NACHSCHLAGEN AUFBEWAHREN.

EN PLEASE KEEP FOR FURTHER REFERENCE.

FR IMPORTANT! A CONSERVER POUR DE FUTURS BESOINS DE REFERENCE.
A LIRE ATTENTIVEMENT.

ITA IMPORTANTE: CONSERVARE PER RIFERIMENTO FUTURO. LEGGERE CON ATTENZIONE.

1

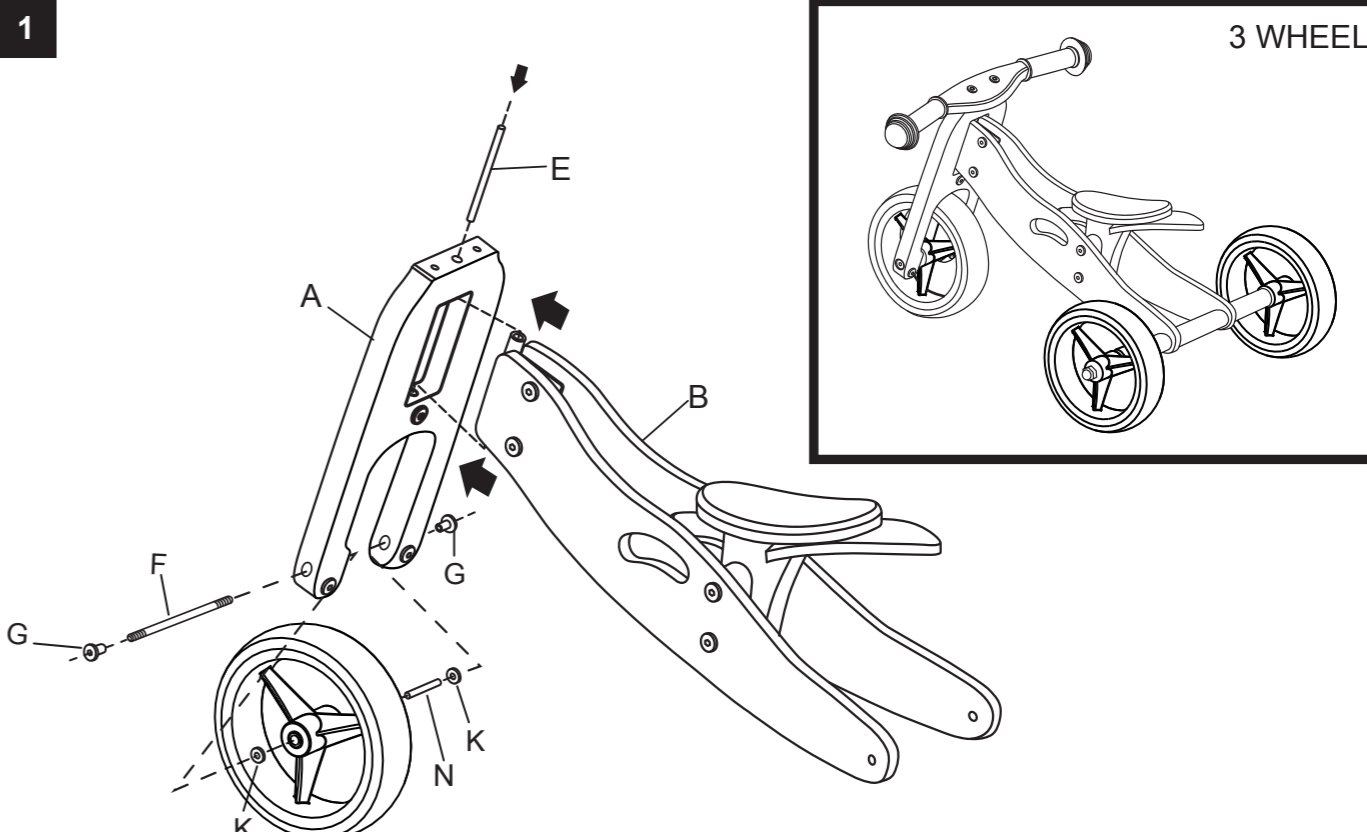

3 WHEEL

A x1 B x1 D x1 E x1 F x1 G x2 N x1 K x2

2

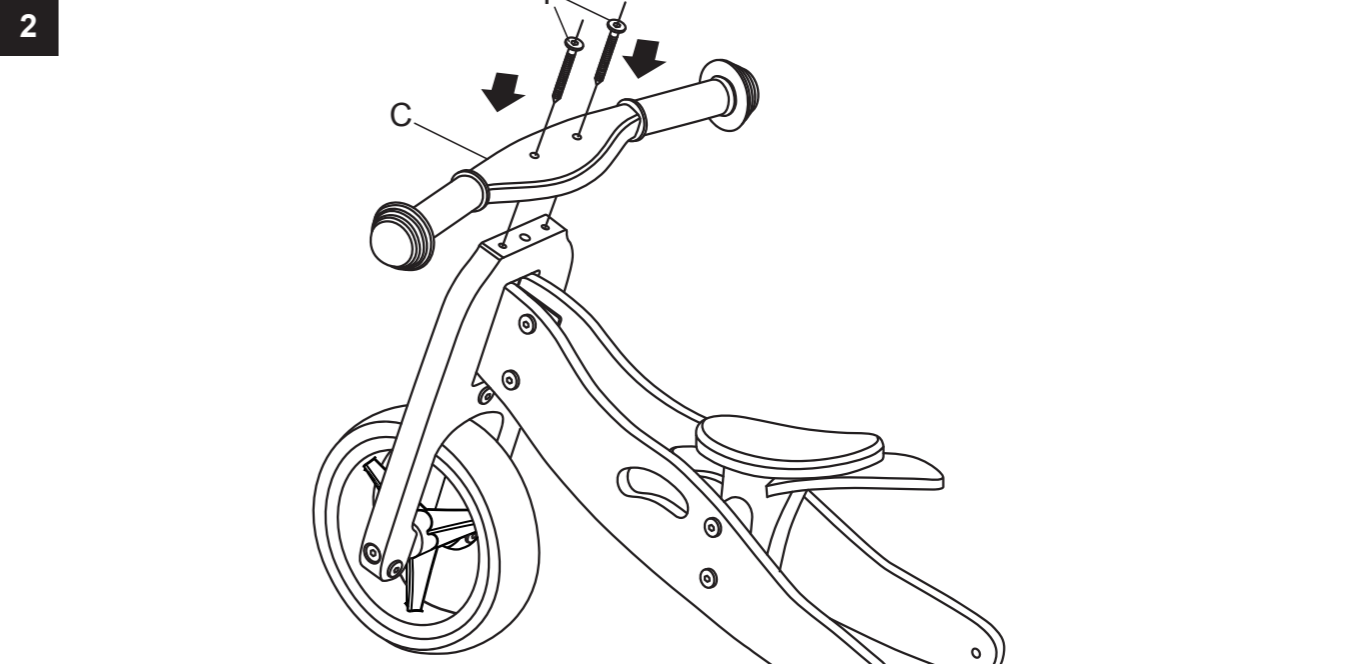

C x1 I x2

3

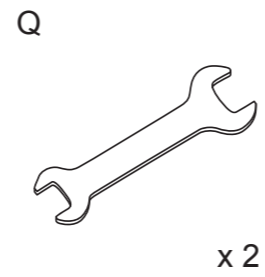
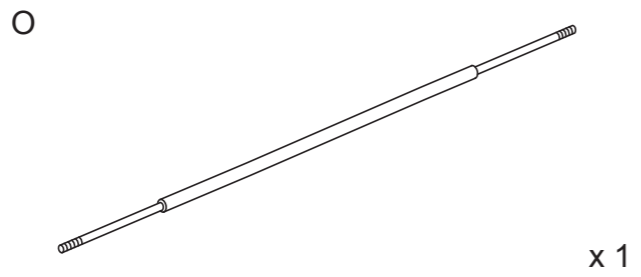
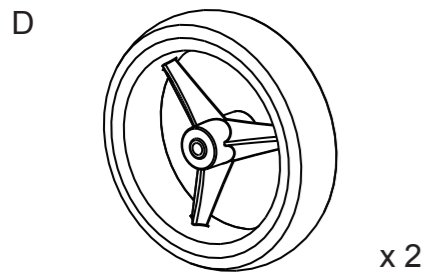
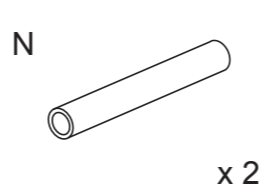
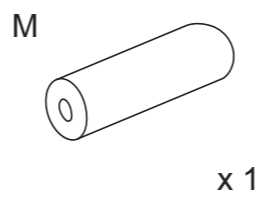
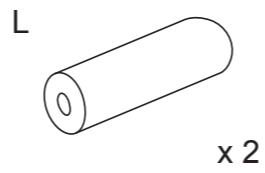
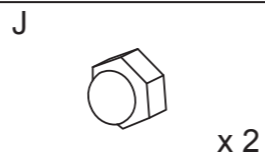
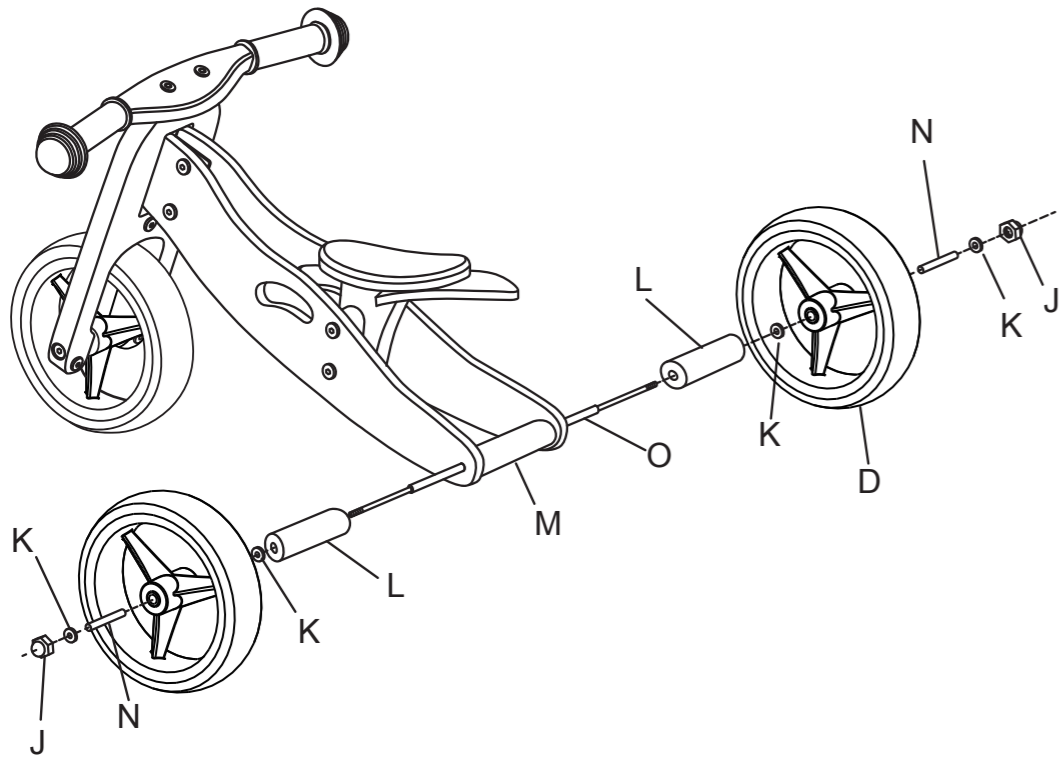

4

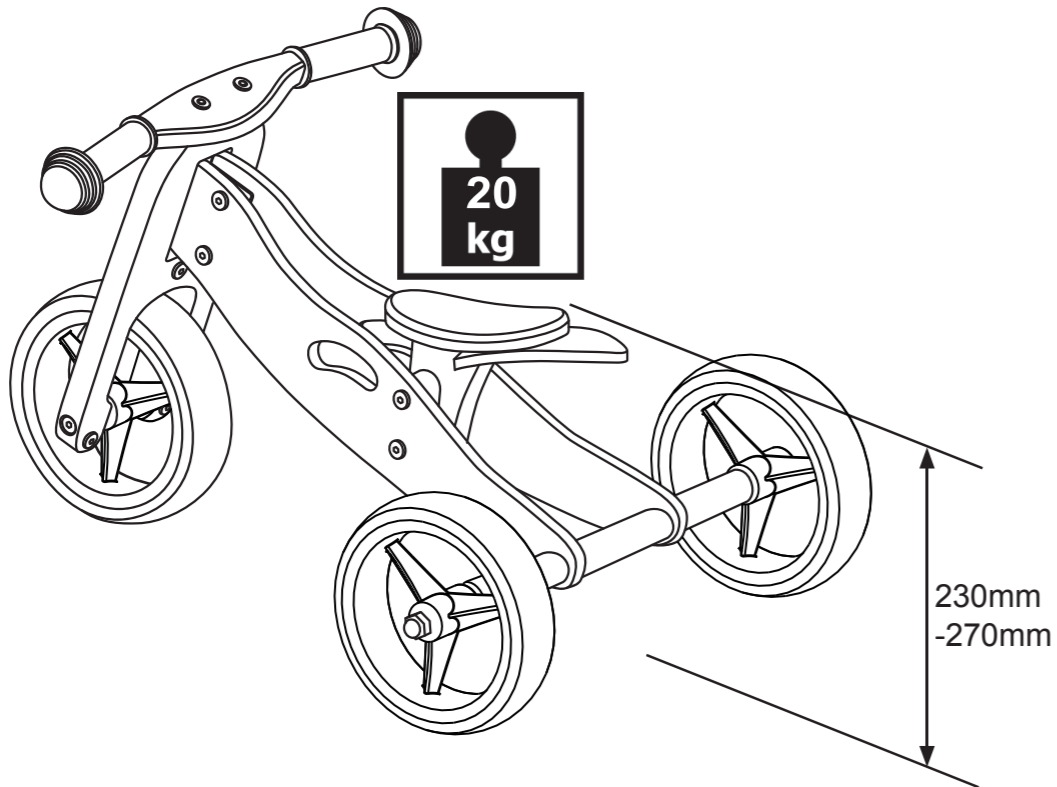

5

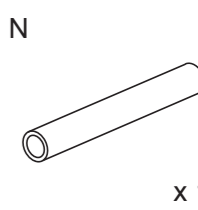
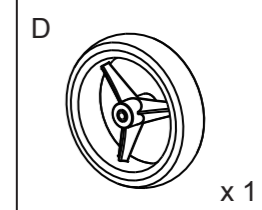
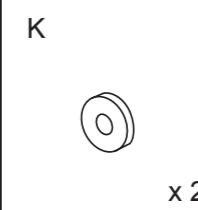
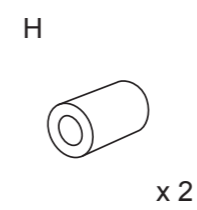
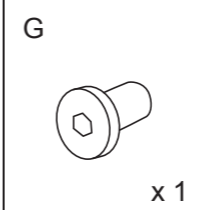
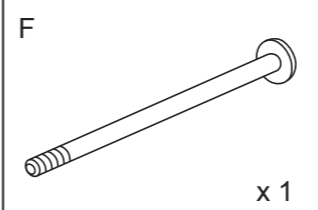
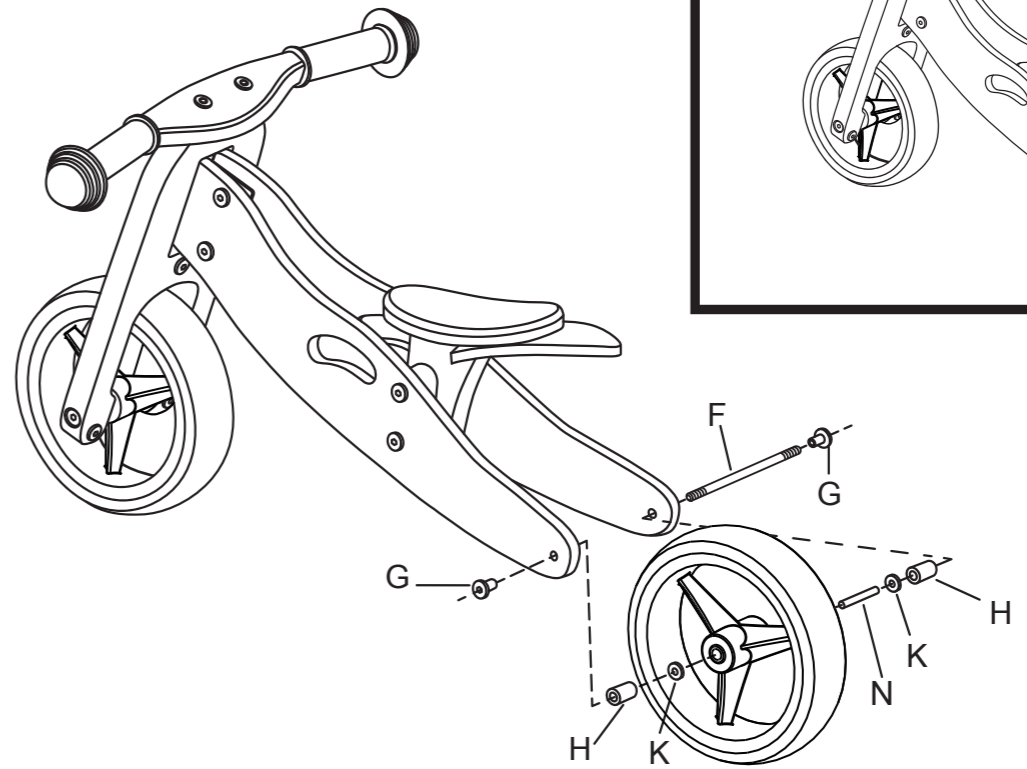

6

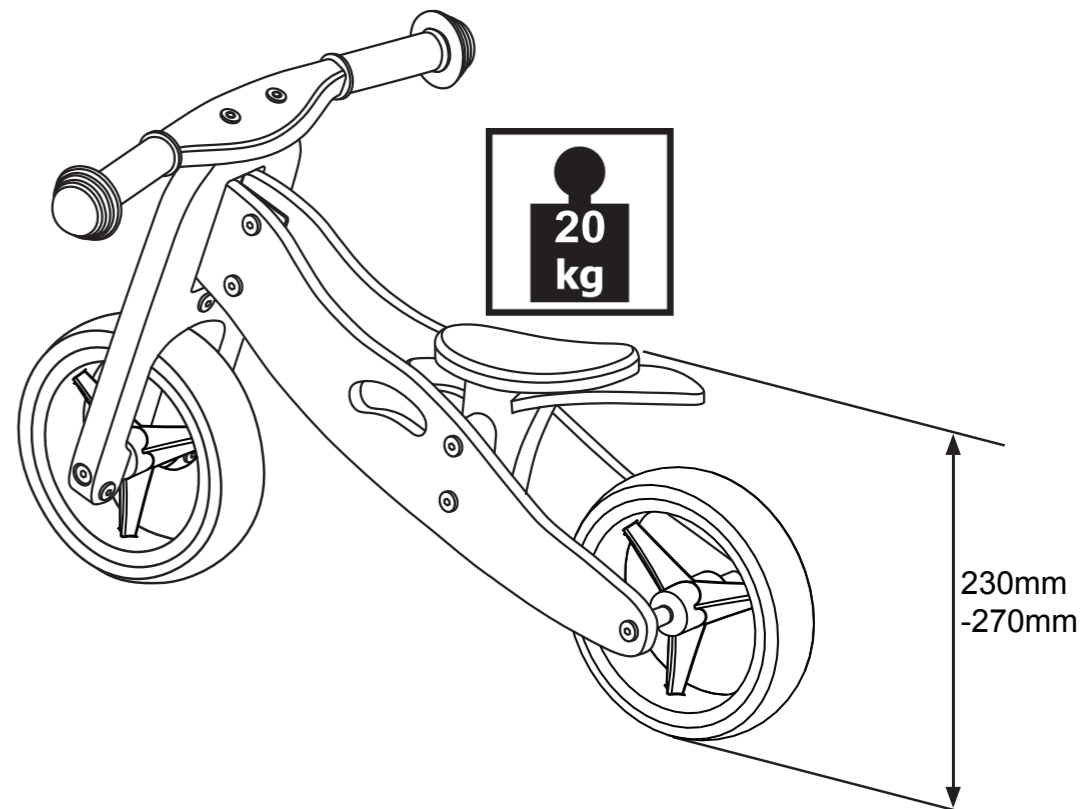

The Mini Balance Bike User Guide

MINI BALANCE BIKE: GUIDA PER L'UTILIZZATORE

Thank you choosing the Mini Balance Bike!
Grazie per aver scelto la Mini Balance Bike!

Warning: Protective equipment should be worn, Not to be used in traffic.
Attenzione: dovrebbero essere utilizzati indumenti protettivi.
Non usare nel traffico.

Safety First:
Prima di tutto la sicurezza:

Please read this manual fully to ensure you have a fun and safe time with your product.

Siete pregati di leggere interamente questo manuale per assicurarvi il divertimento e per passare del tempo in totale sicurezza con il vostro prodotto.

- The toy should be used with caution since skill is required to avoid falls or collisions causing injury to the user or third parties.

Il gioco dovrebbe essere usato con cautela; è richiesta abilità per evitare cadute o collisioni che causino ferite all'utilizzatore o a terzi.

- Parents or adult supervision is recommended at all times. You must ensure your child is confident and capable of stopping before allowing them anywhere near roads/cars and should develop an awareness of road rules and safety.

E' sempre consigliata la supervisione di un genitore o di un adulto. Dovete accertarvi che il vostro bambino sia sicuro e capace di frenare prima di lasciarlo andare vicino a strade/automobili e deve acquisire consapevolezza delle regole della strada e della sicurezza.

- When your child is using the MINI bike on a public footpath, please be aware of driveways and the danger of reversing cars.

Quando il vostro bambino sta usando la Mini Bike su un percorso pubblico fate attenzione ai sensi di marcia ed al pericolo di retromarcia delle automobili.

- These bikes are designed to allow young children to learn to get their balance on a bike, they should not be used on public roads.

Queste biciclette sono progettate per consentire ai bambini di imparare ad acquisire equilibrio su una bicicletta. Non dovrebbero essere utilizzate su strade pubbliche.

- The Mini Balance Bikes are designed for children aged 18 month +.
Le Mini Balance Bike sono progettate per bambini dai 18 mesi in su.

- This product should be assembled by an adult.

Please ensure all fittings are tight and everything is correctly assembled before use.

Questo prodotto dovrebbe essere montato da un adulto. Si prega di assicurarsi che tutti i raccordi siano ben stretti e che tutto sia correttamente assemblato prima dell'utilizzo.

- These bikes are designed to take only one child at a time weighting less than 20KGS.

Queste biciclette sono progettate per portare un solo bambino alla volta, che pesi meno di 20Kg.

- Do not leave this product in the rain, if it gets wet, remove water with a towel to prevent surface rusting or delamination.

Non lasciare il prodotto alla pioggia; se si bagna rimuovete subito l'acqua con un panno per evitare che la superficie arrugginisca o si sfaldi.

- Tighten the nuts and bolts on a regular bases to ensure safety.
Stringete viti e bulloni regolarmente, per garantire la sicurezza.