

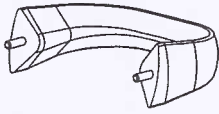











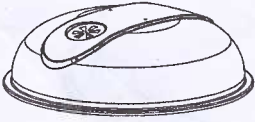
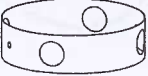



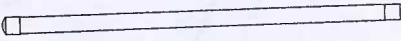



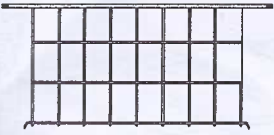





1		3pcs	9		1pc
2		1pc	10		2pcs
3		1pc	11		1pc
4		1pc	12		1pc
5		4pcs	13		1pc
6		2pcs	14		1pc
7		2pcs	15		1pc
8		1pc	16		1pc

A.	M5x12   	1set	D.	M6x15   	3sets
B.	M6  	11sets	E.	M8  	2sets
C.	M6x30  	4sets			

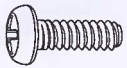

STEP 5.

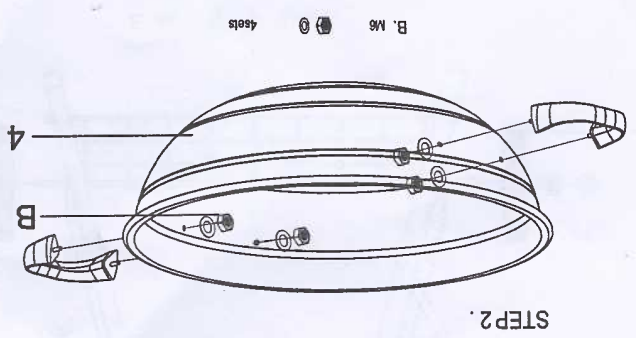
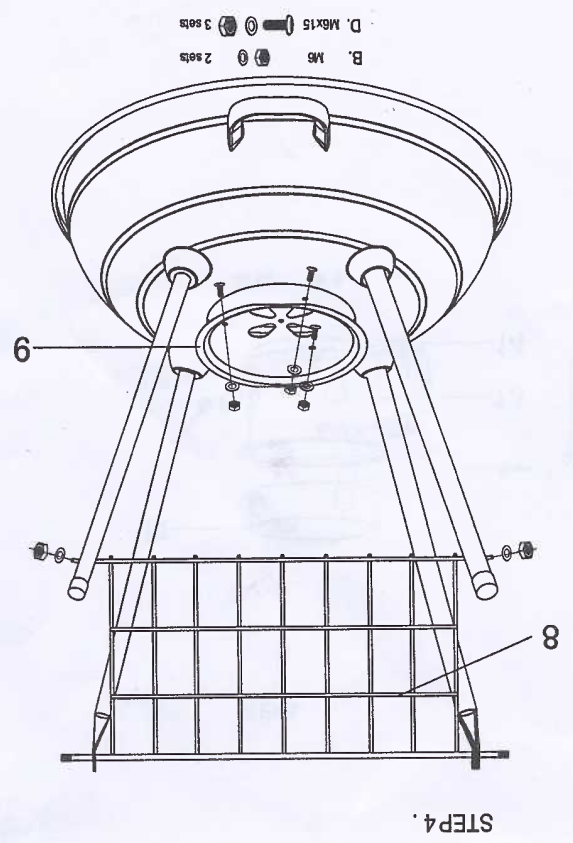
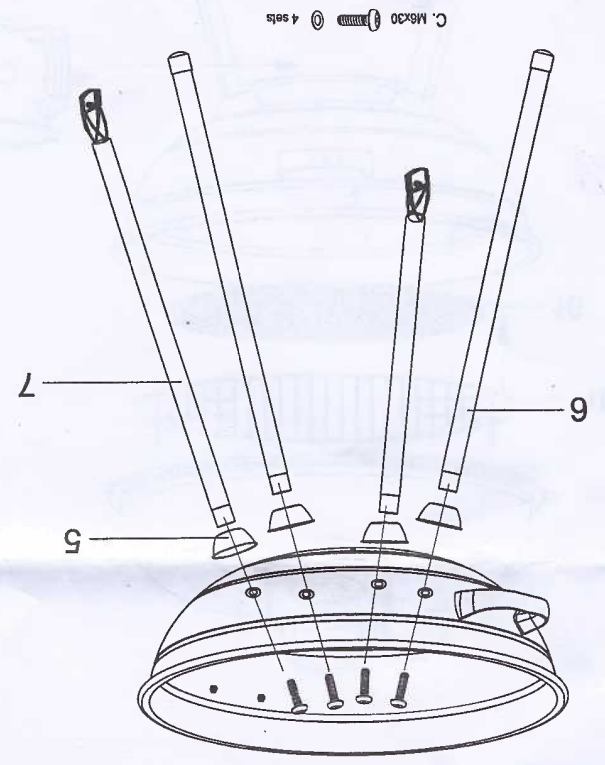
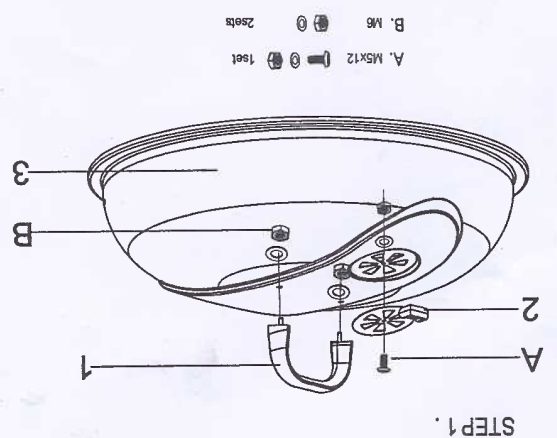
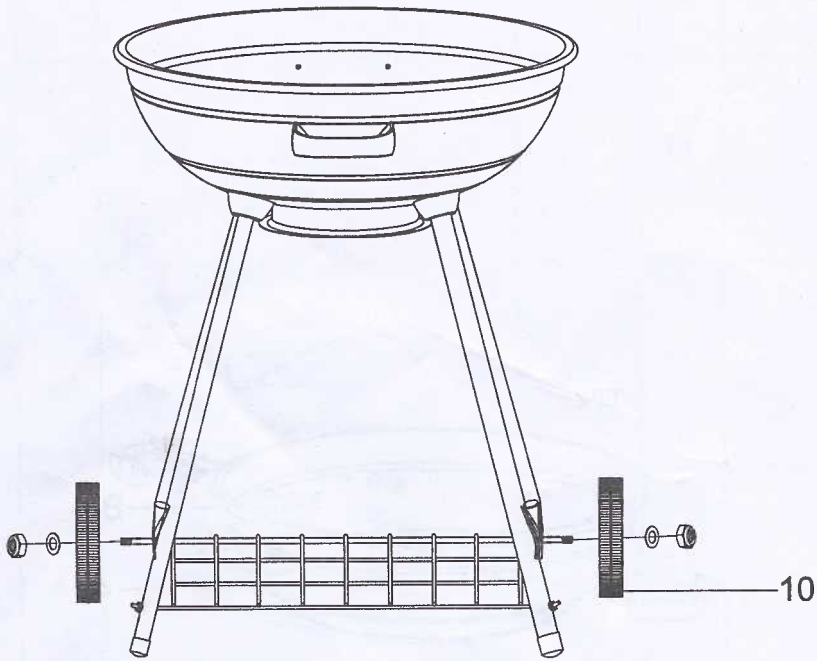

E. M8   2sets

STEP 6.

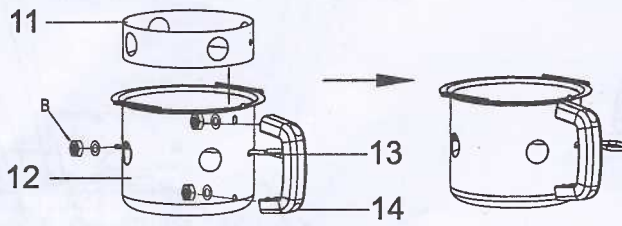

B. M6   3sets

