



# CITY

60051





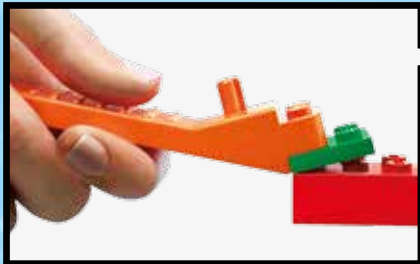
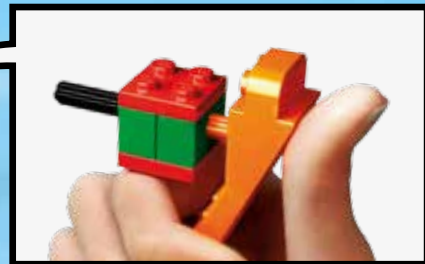

[LEGO.com/brickseparator](https://LEGO.com/brickseparator)



2x

+

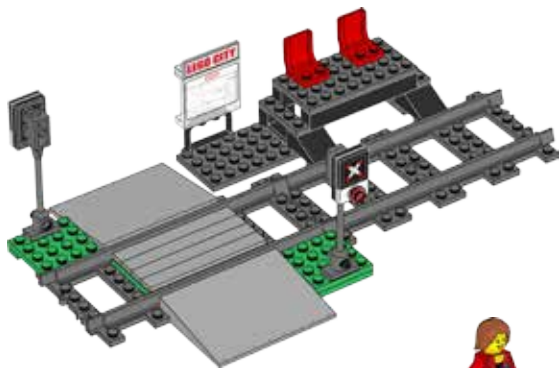

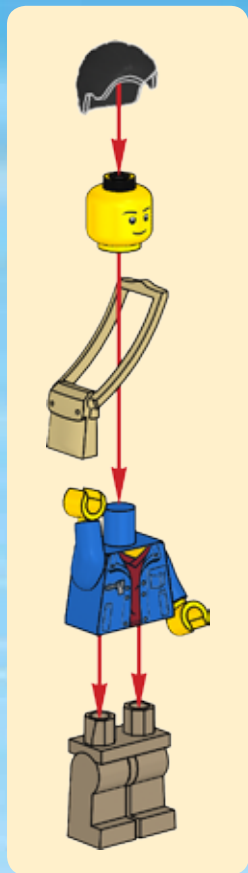

1

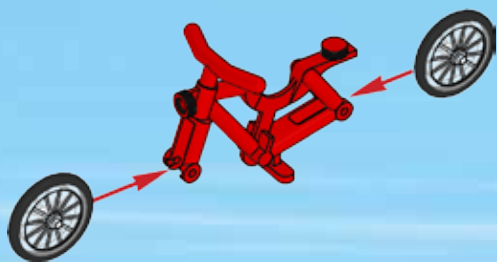

2



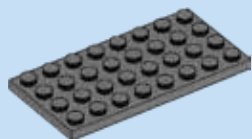
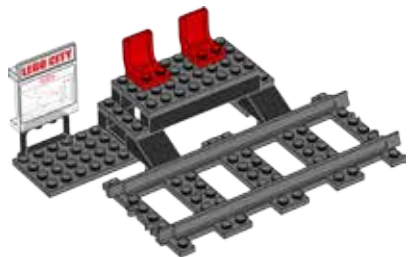

1x

1

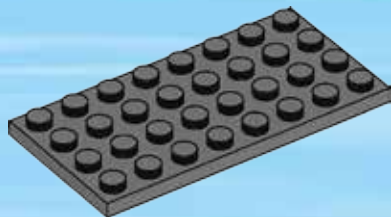

1x



1x

2

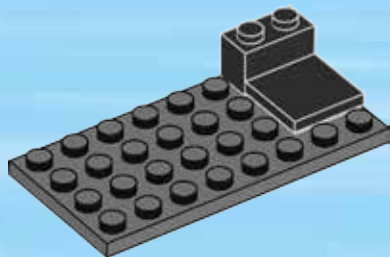



1x

3

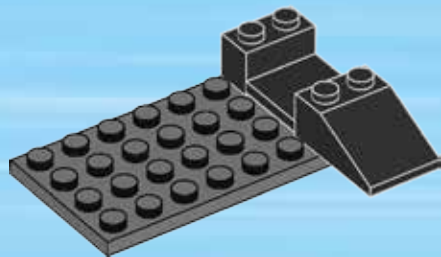





1x

4

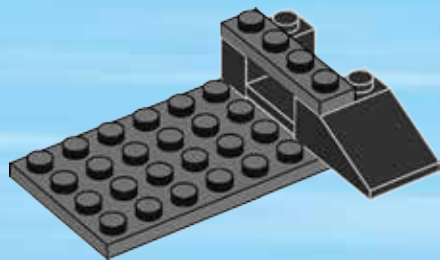

2x

5

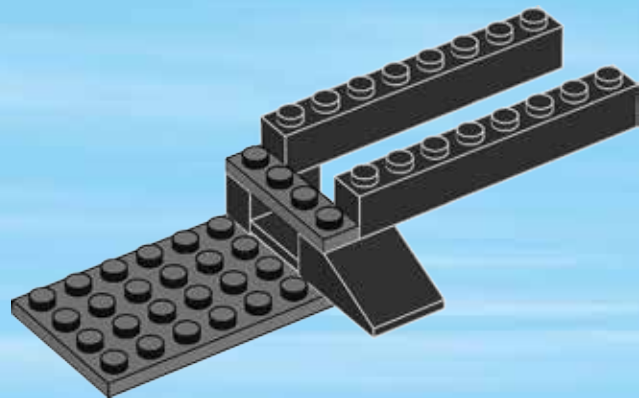

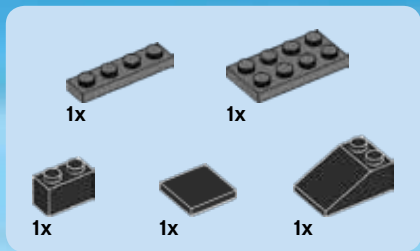

# 6

## 1



## 2



## 3

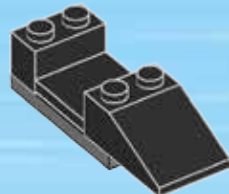

4

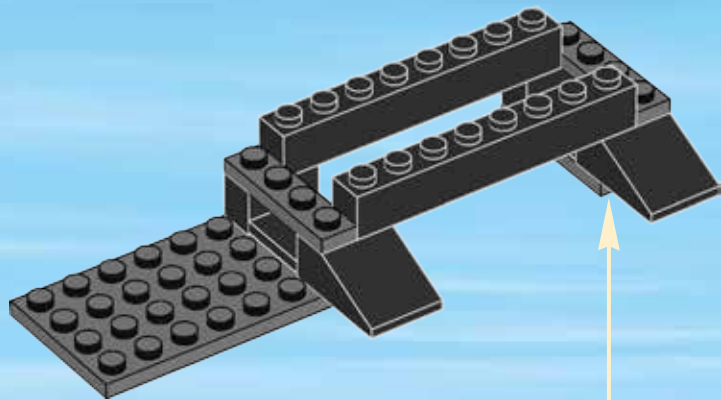
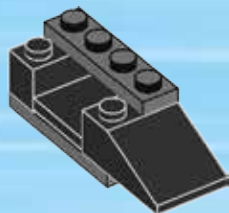



7

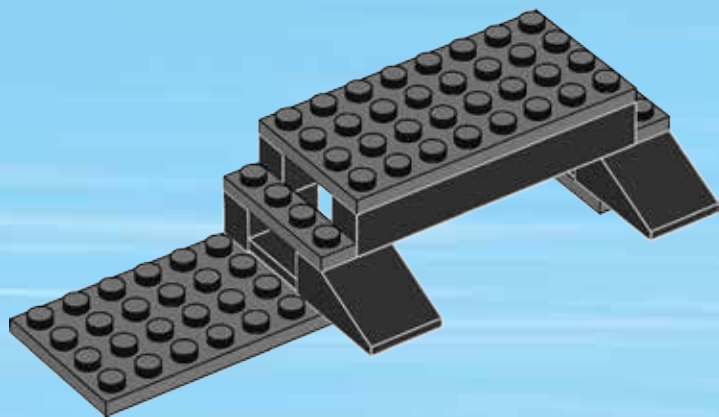



2x



1x

8

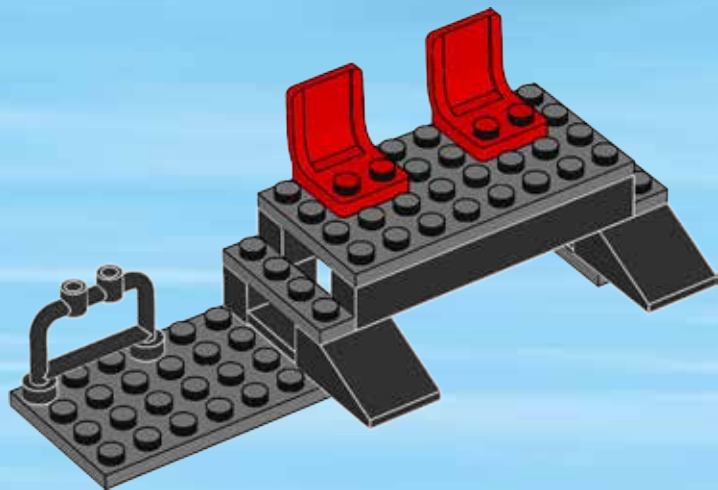

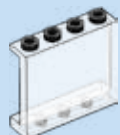

1x

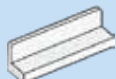

1x

# 9

## 1



## 2

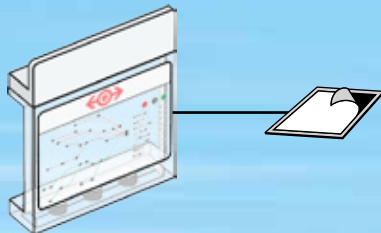

## 3



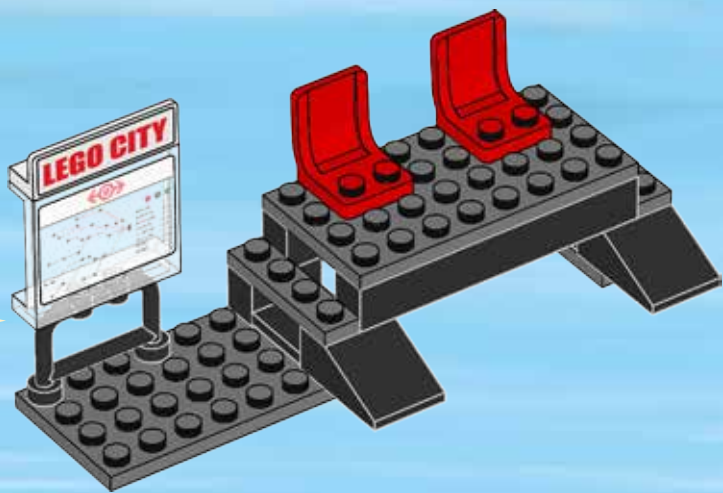

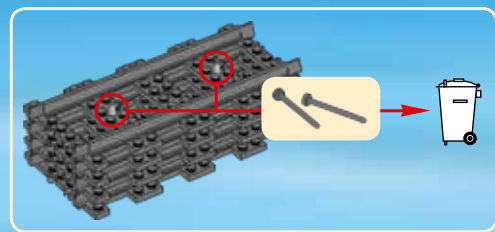
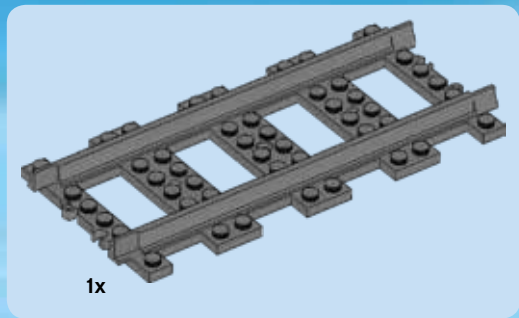

10

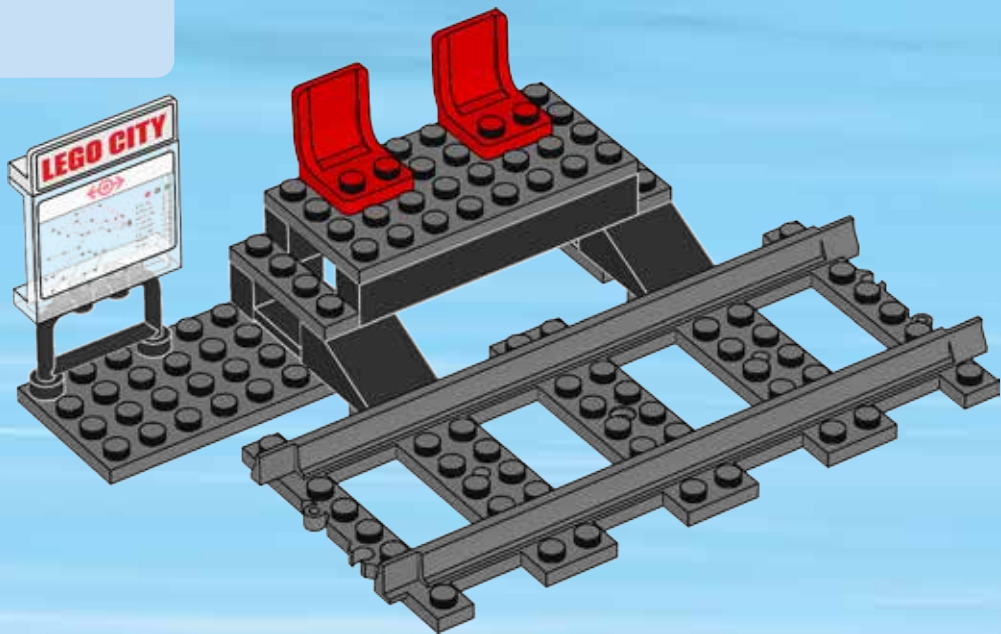



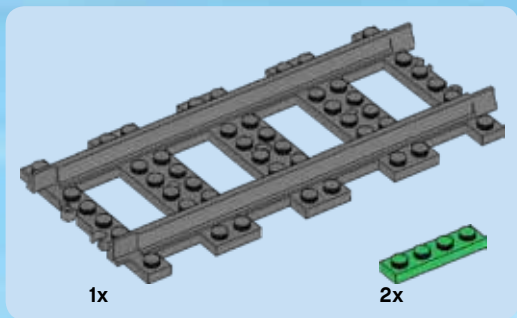
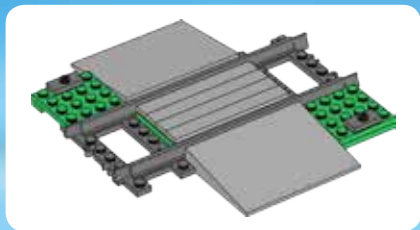

1

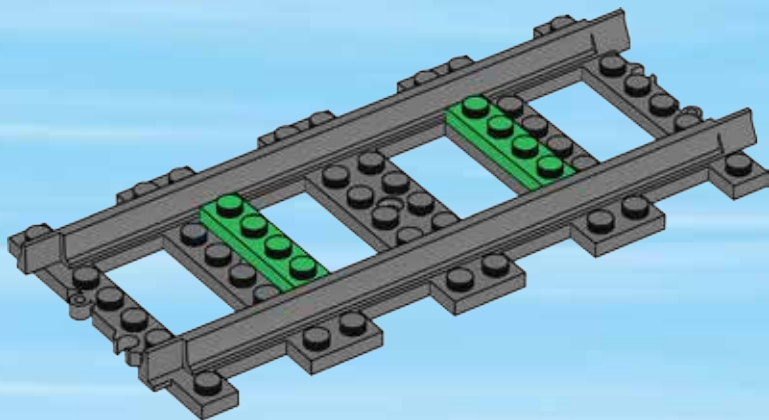

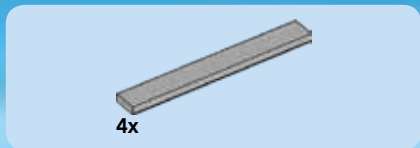

2

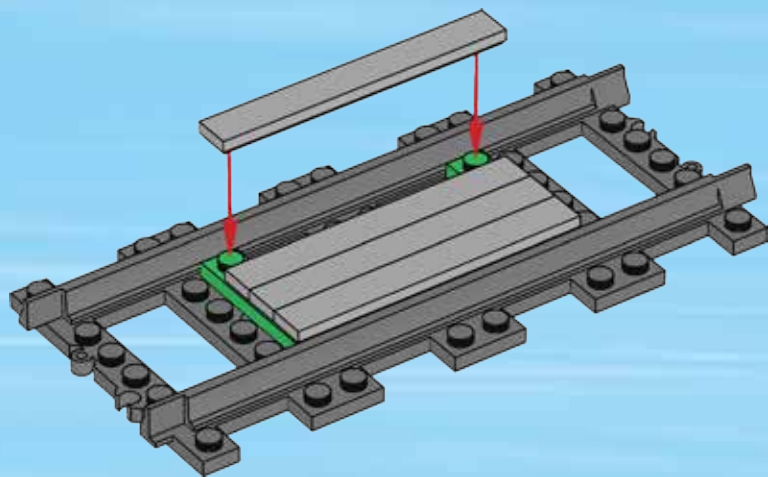

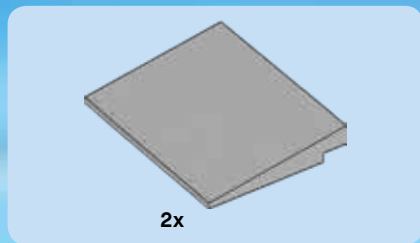

3

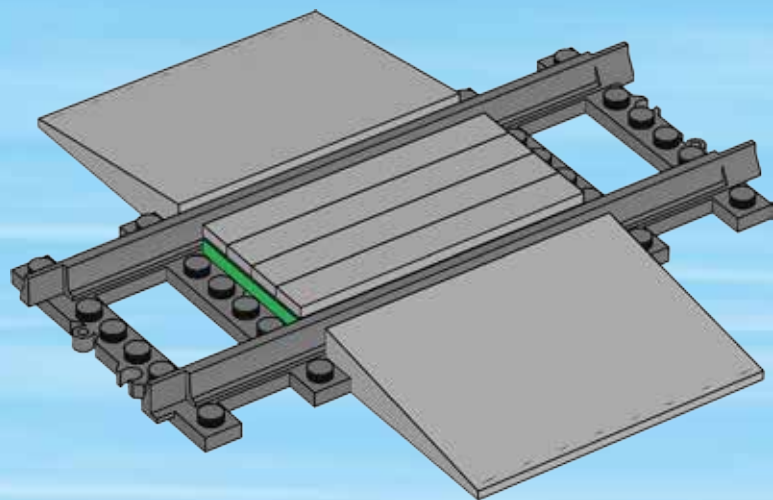

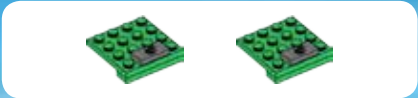

4

1



2

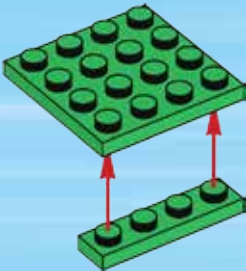

3

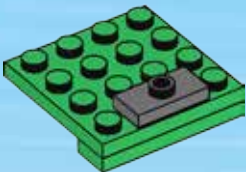

2x

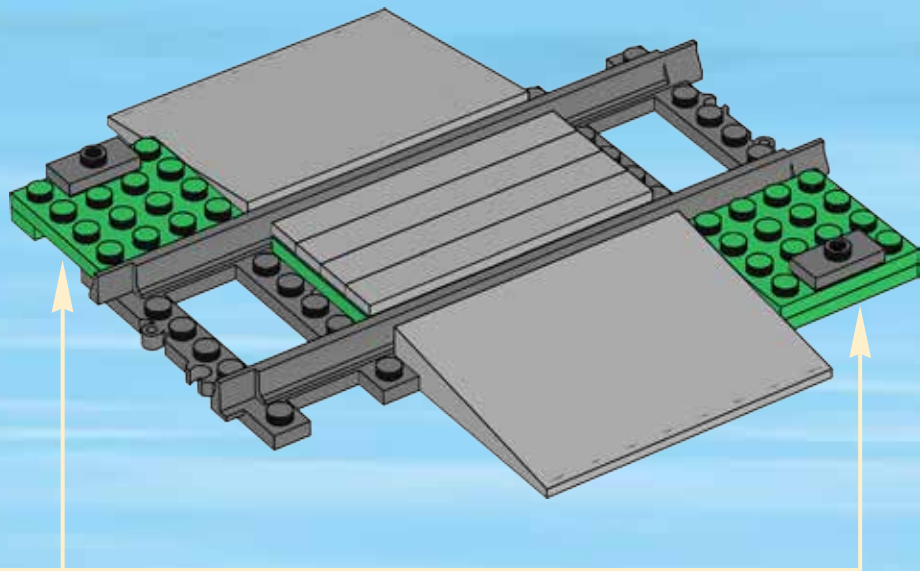



5

1

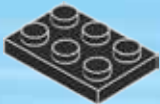

2

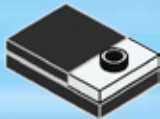

3



4



5

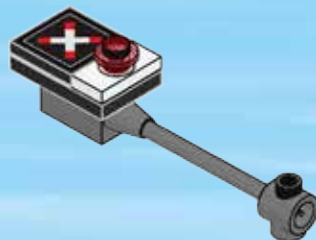

2x

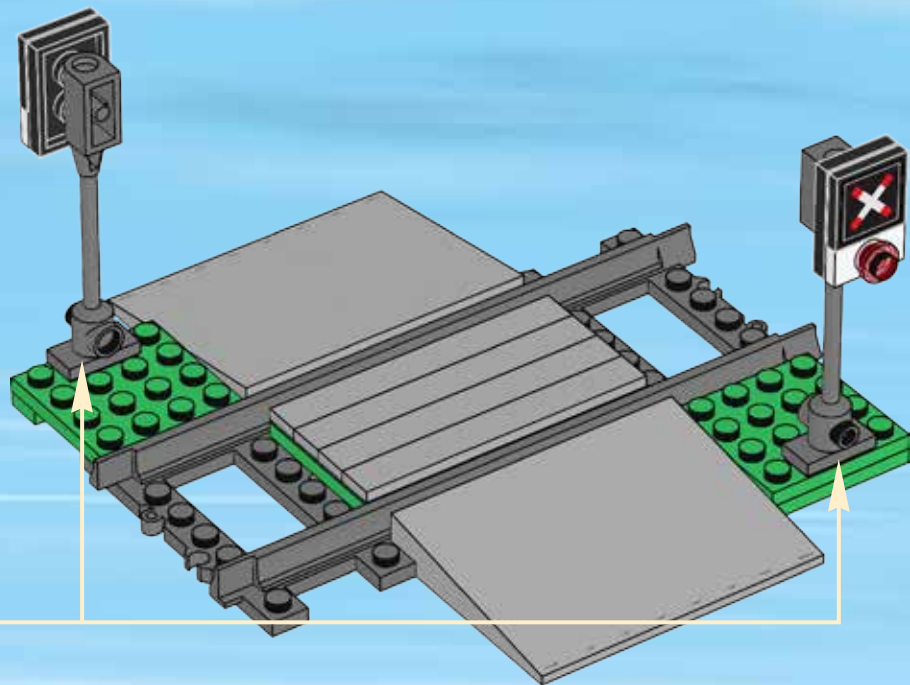



6

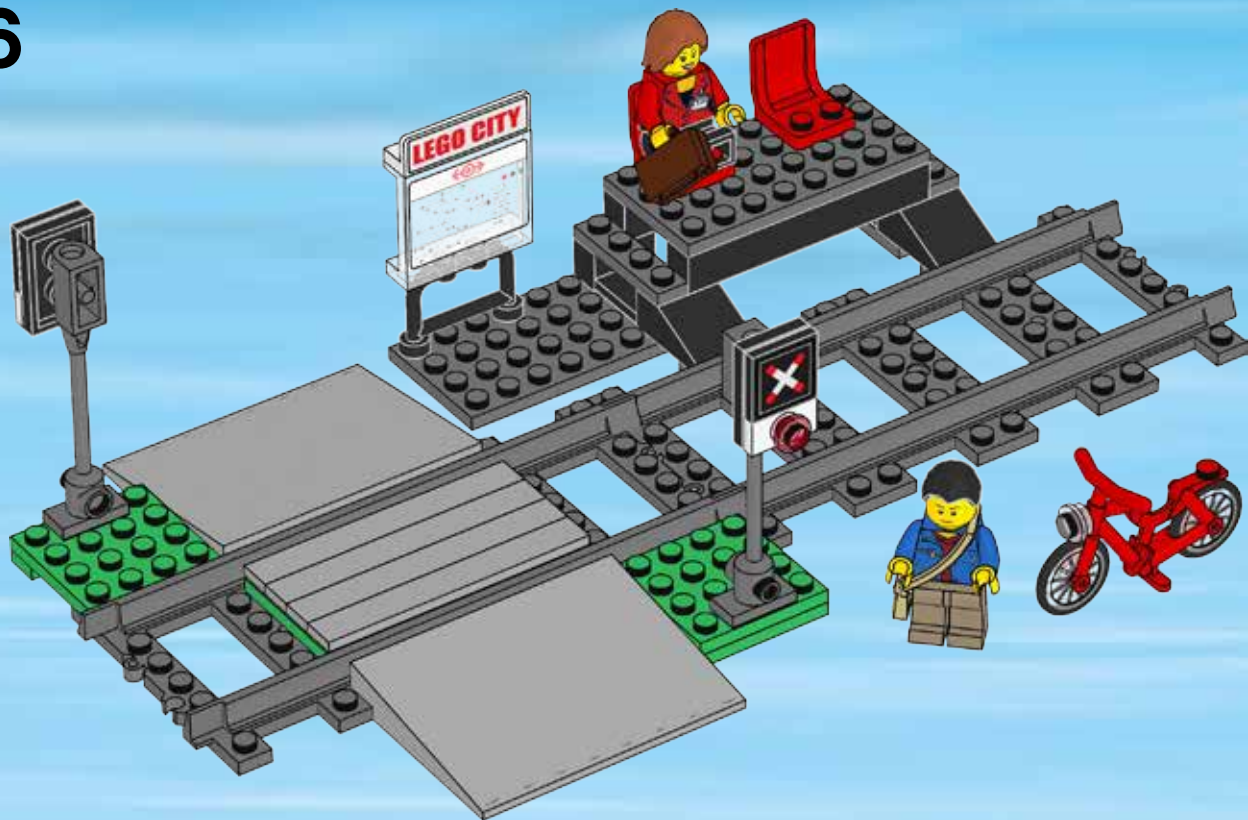



# CITY



60051



60052



60050

[LEGO.COM/CITY](http://LEGO.COM/CITY)



60130



60129



60128



60127



60126

# WIN

GO TO [WWW.LEGO.COM/PRODUCTFEEDBACK](http://WWW.LEGO.COM/PRODUCTFEEDBACK) AND  
GIVE US YOUR SHORT **FEEDBACK** ABOUT THIS  
LEGO® SET FOR A CHANCE TO WIN  
A COOL LEGO PRIZE.



## LEGO.com/productfeedback

### GEWINNE



Erzähle uns auf  
[www.LEGO.com/productfeedback](http://www.LEGO.com/productfeedback)

etwas über die Erfahrungen, die du mit  
diesem LEGO® Set gemacht hast, und  
sichere dir die Chance auf einen coolen  
LEGO Preis!

### GAGNE



Rends-toi sur  
[www.LEGO.com/productfeedback](http://www.LEGO.com/productfeedback)

et donne-nous quelques commentaires  
sur ce produit LEGO® pour avoir une  
chance de gagner un prix LEGO !

### GANAN



Visita  
[www.LEGO.com/productfeedback](http://www.LEGO.com/productfeedback)

y envíanos tu opinión acerca de este set  
LEGO®. ¡Participarás en el sorteo de un  
premio LEGO!

### 获取奖品



登录  
[www.LEGO.com/productfeedback](http://www.LEGO.com/productfeedback)

给出关于此乐高®套装的简短反馈，  
就有机会获得炫酷乐高高奖品

LEGO and the LEGO logo are trademarks of the LEGO Group. ©2014, 2016 The LEGO Group.

6158127