



NEXO KNIGHTS



70333



EN IMPORTANT: Never modify the elements or use other projectiles than provided with this toy.
DE WICHTIG: Die Elemente dürfen nicht verändert werden. Es dürfen ausschließlich die mit dem Spielzeug mitgelieferten Geschosse verwendet werden.
FR IMPORTANT : Ne jamais modifier les éléments ni utiliser d'autres projectiles que ceux fournis avec ce jouet.
IT IMPORTANTE: non modificare gli elementi o utilizzare proiettili non forniti con questo prodotto.
NL BELANGRIJK: Verander niets aan de elementen en gebruik geen andere projectielen dan de bij het speelgoed geleverde.
ES IMPORTANTE: No modifique los elementos ni utilice otros proyectiles diferentes a los suministrados junto con este juguete.
DA VIGTIGT: Elementerne må ikke ændres, og der må ikke bruges andre projektiler end dem, der følger med legetøjet.
IS MIKILVÆGT: Aldrei skal breyta einingum vörunnar eða nota önnur skot en þau sem fylgja þessu leikfangi.
FI TÄRKEÄÄ: Älä koskaan tee osiin muutoksia tai käytä lelussa muita kuin sen sisältyneet ammuksia.
SV VIKTIGT: Modifiera aldrig delarna och använd aldrig andra projektiler än de som medföljer denna leksak.
NO VIKTIG: Elementene må ikke endres, og det må aldri brukes andre projektiler enn dem som følger med leketøyet.
PT IMPORTANTE: Nunca modifique os elementos nem utilize projecteis que não tenham sido fornecidos com este brinquedo.
EL ΣΗΜΑΝΤΙΚΟ: Ποτέ μην τροποποιείτε τα στοιχεία του παιχνιδιού και μην χρησιμοποιείτε άλλα βλήματα εκτός από αυτά που συνοδεύουν αυτό το παιχνίδι.
JA 重要:部品を改造したり、本製品に付属の発射体以外のものを使用しないようにしてください。
ZH 重要提示: 切勿更改组件或使用并非由本玩具附带的弹丸。
KO 중요: 이들 부품을 수정하거나 이 완구와 함께 제공된 것이 아닌 발사체는 결코 사용하지 마십시오.
RU ВАЖНО: Запрещается вносить изменения в элементы или использовать другие снаряды, отличные от тех, которые поставляются с данной игрушкой.
PL WAŻNE: Nigdy nie modyfikować elementów ani nie używać innych pocisków niż dostarczonych z zabawką.
CZ UPOZORNĚNÍ: Nikdy neupravujte součástky a nepoužívejte jiné projektily než ty, které jsou dodávány s touto hračkou.
SK UPOZORNENIE: Nikdy neupravujte súčiastky a nepoužívajte iné projektily než tie, ktoré sú dodávané s touto hračkou.
HU FONTOS: Az elemeket nem szabad módosítani, és a játékhoz adott lövedékek helyett sem szabad mást használni.
UA УВАГА: Ніколи не модифікуйте елементи. Використовуйте тільки снаряди, що входять у комплект цієї іграшки.
HR VAŽNO: Nemojte nikad mijenjati elemente ili koristiti druge projektilne osim onih koji bili priloženi uz ovu igračku prilikom kupnje.
SR VAŽNO: Nemojte da modifikujete elemente i ne koristite druge projektilne osim onih koji dolaze uz ovu igračku.
MK VAŽNO: Nikogash ne menuvajte gi elementite i ne koristete drugi proektili od tie što vi se dadeni so igračkata.
SL POMEMBNO: Nikoli ne spreminjajte elementov in uporabljajte le izstrelke, ki so bili priloženi tej igrački.
RO IMPORTANT: Nu modificați niciodată elementele și nu utilizați alte proiectile decât cele furnizate cu această jucărie.
BG ВАЖНО: В никакъв случай не видоизменяйте елементите и не използвайте други снаряди освен предоставените с тази играчка.
LV SVARĪGI: Nekad nepārveidojiet rotālietas elementus, vienmēr izmantojiet tikai tās komplektā iekļautās lodītes.
ET OLULINE: Mänguasja osi ei tohi teistega asendada, kasutada võib ainult kaasasolevat heitkeha.
LT SVARBU: Niekuomet nekeiskite elementų ir naudokite tik tuos šovinius, kurie yra pridėti prie šio žaislo.
TR ÖNEMLİ: Hiçbir zaman parçalarını değiştirme veya bu oyuncakla verilenler dışında fırlatıcılar kullanmayın.
AR ملاحظة مهمة: تجنب تعديل العناصر أو استخدام مقذوفات أخرى خلاف المرفقة مع هذه اللعبة.
ID PENTING: Jangan pernah memodifikasi elemen atau menggunakan pelet lain selain yang disediakan bersama mainan ini.
MS PENTING: Jangan ubah suai elemen atau guna peluncur lain selain daripada yang disediakan untuk alat mainan ini.

1

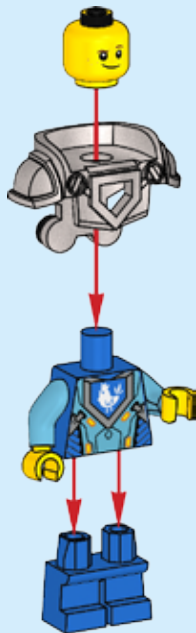

2

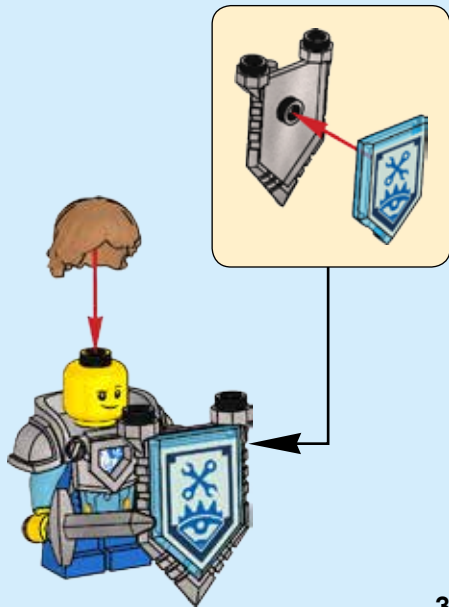

3



3

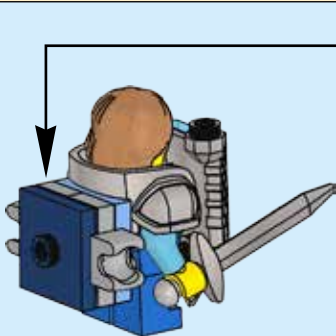
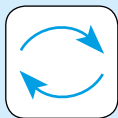

4



1x



2x

4



1x

5

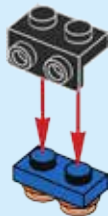



1x

6



6



1x

7

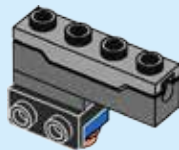



1x

8

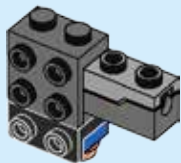

1x

9

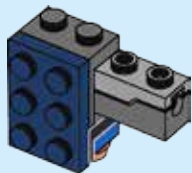



1x

10

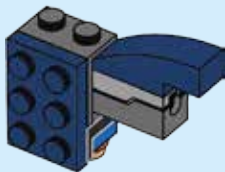

1x



1x

11

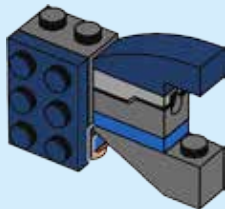
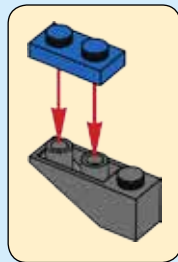

12

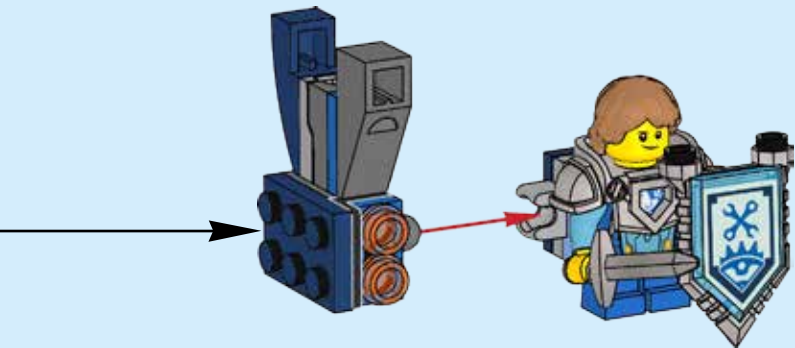
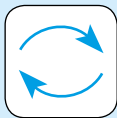



1x



2x

13



10



1x

14

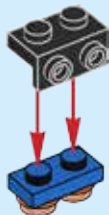



1x

15



1x

16

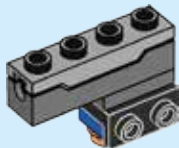



1x

17

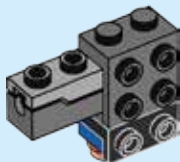

12



1x

18

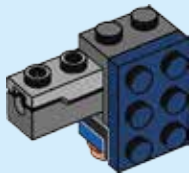

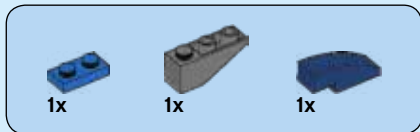

19

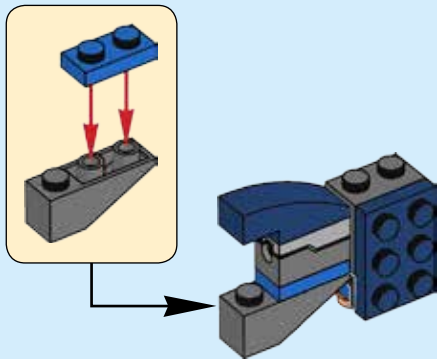

20

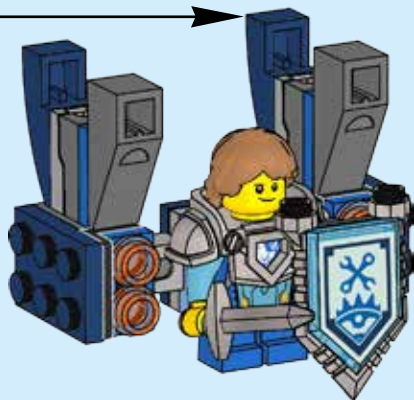



3x



21



22

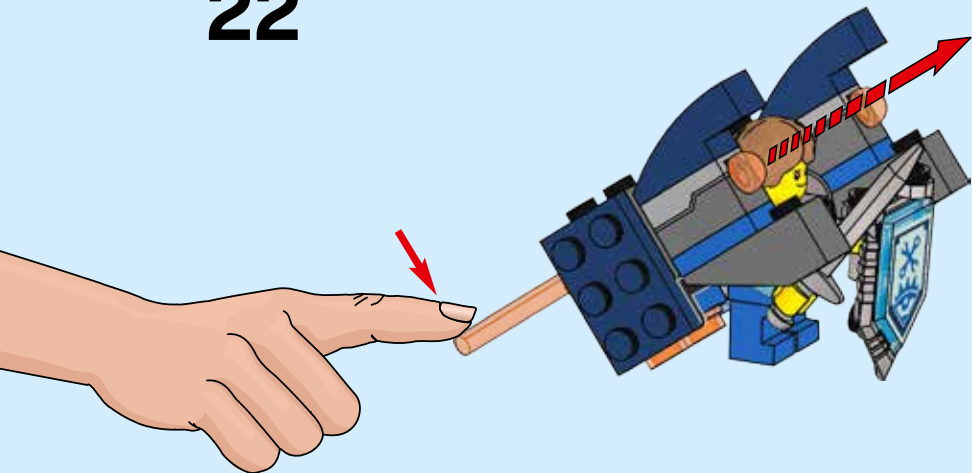

23

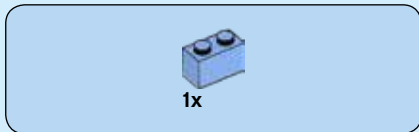
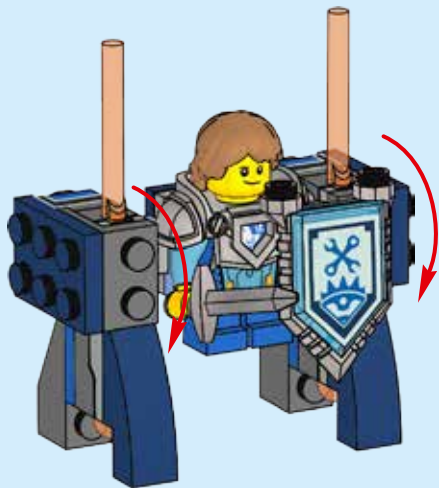

1x

1



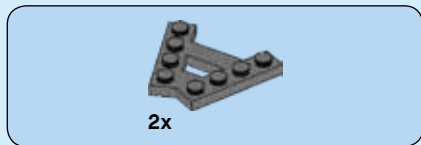

2

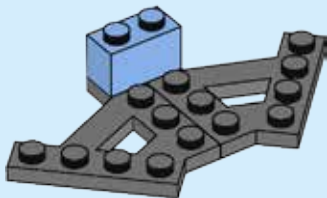

3

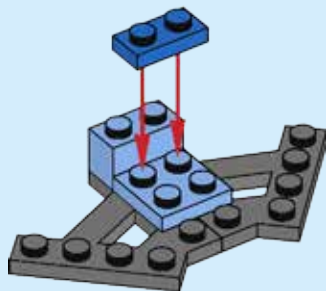



1x

4

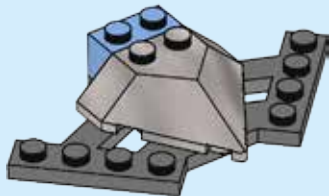

2x

5

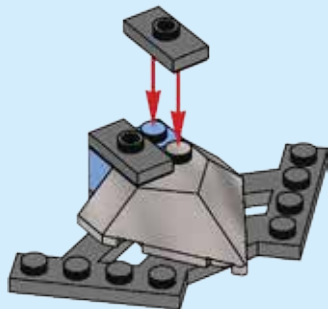

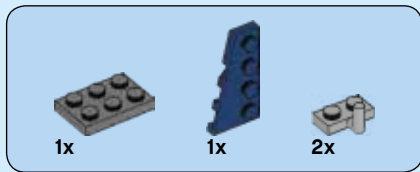

6

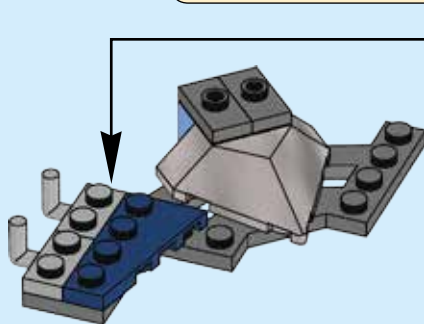
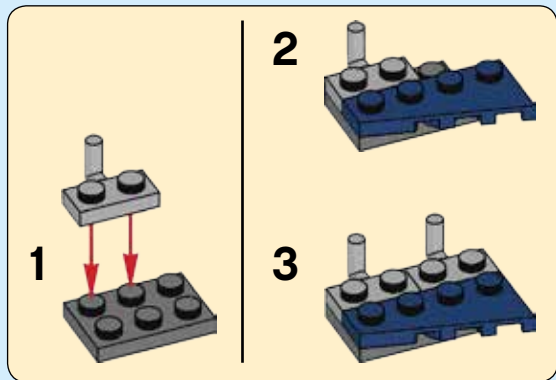

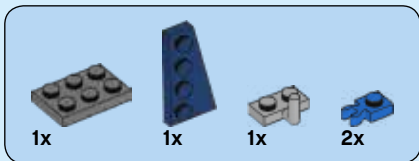

7

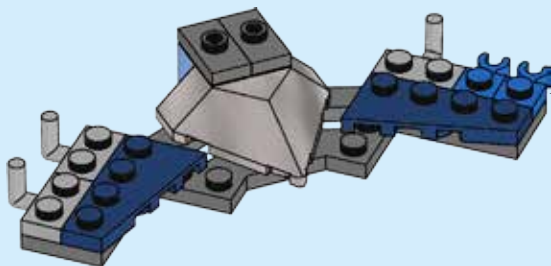
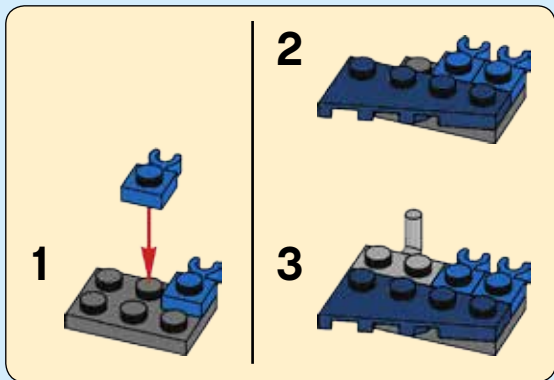



2x



2x

8

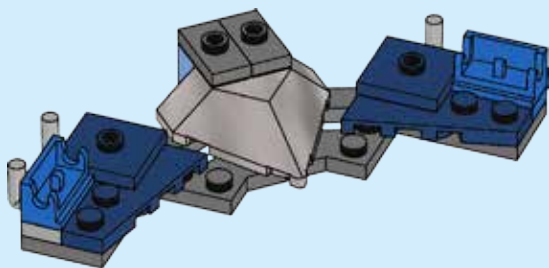

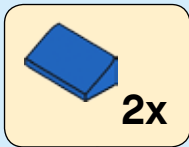

9

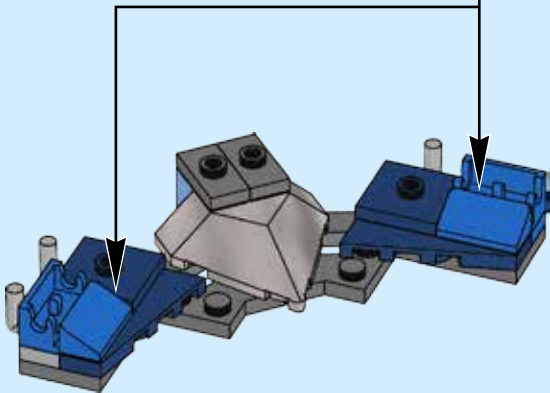



2x

10

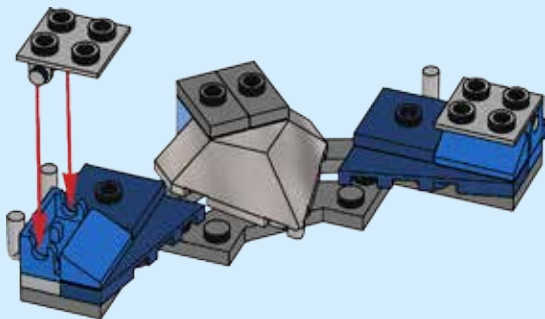



1x



3x

11

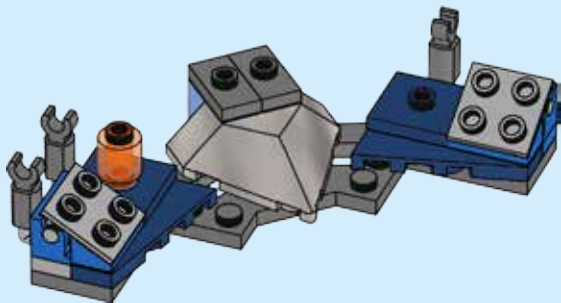



2x



1x



1x

12

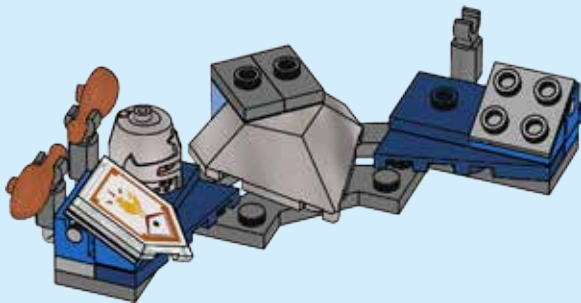



1x



1x

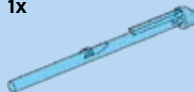

2x



1x

13



14





1x



1x



1x

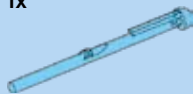

2x





1x



2x



1x





NEXO KNIGHTS



DOWNLOAD
THE FREE APP



LEGO® NEXO KNIGHTS™: MERLOK 2.0



DOWNLOAD THE FREE APP / KOSTENLOSE APP HERUNTERLADEN / TÉLÉCHARGE L'APPLI GRATUITE
DESCARGA LA APP GRATIS / DESCARREGA A APP GRÁTIS / TÖLTSD LE AZ INGYENES APPOT! / 下载免费 APP
DEVICE CHECK: / GERÄT PRÜFEN: / VÉRIFICATION DE COMPATIBILITÉ :
COMPRUEBA TU DISPOSITIVO: / VERIFICAÇÃO DO DISPOSITIVO: / ESZKÖZELLENÖRZÉS: / 设备检查:

LEGO.com/devicecheck



NEXO KNIGHTS



SCANNING TIPS

Scanning Tips / Tipps zum Scannen / Conseils de scannage / Consejos para escanear
Dicas para o scan / Beolvasási tippek / 扫描提示



LEGO.COM/NEXOKNIGHTS/HELP



NEXO KNIGHTS



LEGO
LEGOLAND
DISCOVERY CENTER
LEGO
LEGOLAND



**DOWNLOAD THE FREE APP:
KOSTENLOSE APP HERUNTERLADEN:
TELECHARGE L'APPLI GRATUITE :
DESCARGA LA APP GRATIS:
DESCARREGA A APP GRÁTIS:
TÖLTSD LE AZ INGYENES APPOT!:**
下载免费APP:

LEGO® NEXO KNIGHTS™: MERLOK 2.0

ALL MATERIALS MIGHT NOT BE AVAILABLE IN ALL MARKETS./MÖGLICHERWEISE IST NICHT DAS GANZE MATERIAL IN ALLEN MÄRKTEN VERFÜGBAR./CERTAINS PRODUITS PEUVENT NE PAS ÊTRE DISPONIBLES SUR CERTAINS MARCHÉS./CIERTOS MATERIALES PODRÍAN NO ESTAR DISPONIBLES EN TODOS LOS MERCADOS./OS MATERIAIS PODERÃO NÃO ESTAR TODOS DISPONÍVEIS EM TODOS OS MERCADOS./ELKEPZELHETO, HOGY BIZONYOS KIEGÉSZÍTŐK A TE ORSZÁGODBAN NEM ELÉRHETŐEK./部分内容可能不适用于某些国家/地区

LEGO.COM/NEXOKNIGHTS

LEGO

**NEXO
KNIGHTS**



70330



70331



70332



70333



70334



70335



NEXO KNIGHTS™



SPARKKS
70316



JESTRO
70316



BOOK OF MONSTERS
70316



MOLTOR
70313



BEAST MASTER
70314



CRUST SMASHER
70311



ASH ATTACKER
* 70310 / 70315 / 70317



FLAME THROWER
70312



SCURRIER
* 70315 / 70317



ULTIMATE BEAST MASTER
70334

ULTIMATE LAVARJA
70335

* Weapons and decorations vary by set/Zubehör und Dekoration variieren je nach Set/
Les armes et les décorations varient selon les boîtes/ Las armas y accesorios varían según el set/



ULTIMATE CLAY
70330

ULTIMATE MACY
70331

ULTIMATE AARON
70332

ULTIMATE ROBIN
70333



AARON
* 70313 / 70317



AXL
70317



LANCE
* 70312 / 70316



MACY
70314



CLAY
* 70315 / 70317



CHEF ÉCLAIR
70317



LANCE BOT
70312



CLAY BOT
70315



ROYAL SOLDIER
* 70310 / 70311



MERLOK 2.0
70317

As armas e decorações variam consoante o conjunto/
A Fegyverek és dekorációk készletenként változnak./ 套装不同，武器和装饰各有不同





NINJAGO™

Masters of Spinjitzu



LEGO.COM/NINJAGO



NEXO KNIGHTS



LEGO.COM/NEXOKNIGHTS



club™





1x
6060843



2x
4613257



2x
4651236



1x
4543857



2x
393723



5x
302323



1x
6125671



1x
6125384



2x
6016172



2x
4278013



1x
6133403



1x
6133350



2x
6065898



3x
6124908



1x
4153989



4x
3005747



1x
6133414



1x
4179833



2x
4653540



1x
4514700



1x
4529954



1x
4502091



2x
4540280



3x
4565320



2x
4530028



2x
6043656



3x
4611702



2x
4211881



2x
6048898



2x
4211043



3x
6015890



2x
6039479



2x
6092572



2x
6117972



2x
4211068



2x
6133811



1x
6133830



1x
6135468



1x
6037510



1x
6129453



1x
6129534



1x
6078442



Customer Service

Kundenservice

Service Consommateurs

Servicio Al Consumidor

LEGO.com/service or dial



: 00800 5346 5555

: 1-800-422-5346

WIN

GO TO WWW.LEGO.COM/PRODUCTFEEDBACK AND
GIVE US YOUR SHORT **FEEDBACK** ABOUT THIS
LEGO® SET FOR A CHANCE TO WIN
A COOL LEGO PRIZE.



LEGO.com/productfeedback

GEWINNE



Erzähle uns auf
www.LEGO.com/productfeedback

etwas über die Erfahrungen, die
du mit diesem LEGO® Set gemacht
hast, und sichere dir die Chance auf
einen coolen LEGO Preis!

GAGNE



Rends-toi sur
www.LEGO.com/productfeedback

et donne-nous quelques commen-
taires sur ce produit LEGO® pour
avoir une chance de gagner un
prix LEGO !

GANA



Visita
www.LEGO.com/productfeedback

y envíanos tu opinión acerca de este
set LEGO®. ¡Participarás en el sorteo
de un premio LEGO!

获取奖品



登录
www.LEGO.com/productfeedback

给出关于此乐高®套装的简短反馈，
就有机会获得炫酷乐高奖品

LEGO, the LEGO logo and NEXO KNIGHTS are trademarks of the LEGO Group.
©2016 The LEGO Group.

6154042